

PA653U/PA803U/PA853W/PA903X Installation Guide

Desktop and Ceiling Mount

Rev 1.0

Contents

Product Description, Lens Specs, Screen/Aspect Ratio	
Notes and Formulas	Pg 1
Distance Charts and Formulas	Pg 2-4
Ceiling Mount/Desktop Installation	Pg 5
Lens Shift Adjustable Range	Pg 6
Cabinet Dimensions	Pg 7
Cabinet Dimensions	Pg 8
Lens Dimensions (Optional)	Pg 9-12
Ceiling Mount Dimensions and Input Panel	Pg 13
Control Codes	Pg 14



Product Description

Type:	3 panel LCD projector, 0.8 p-Si TFT w/MLA	Dimensions:	19.8"(W) x 6.6"(H) x 14.4"(D)
		Weight:	18.5 lbs
Resolution:	1920 x 1200 (16:10) 1920 x 1200 (16:10) 1280 x 800 (16:10) 1024 x 768 (4:3)	Brightness:	PA653U: 6500 Lumens PA803U: 8000 Lumens PA853W: 8500 Lumens PA903X: 9000 Lumens
Fan Noise:	39 dB / 33dB @ 1 meter		
Power Consumption:	460W (max)	BTU's:	1571 BTU/hour

Network Ready, integrated wired and wireless adapter
Manual: Lens Shift, Horizontal & Vertical /Zoom/ Focus

Lens Specifications

NP11FL:	Throw Ratio: ~ 0.8:1 Screen Sizes: 40"-150"	Focal Length: 13.2mm F/#:2.3	NP30ZL:	Throw Ratio: 0.79 – 1.04:1 Screen Sizes: 40" - 500"	Focal Length: 13.2 – 17.2mm F/#:1.9 -2.1
NP12ZL:	Throw Ratio: 1.16 - 1.52:1 Screen Sizes: 30" - 500"	Focal Length: 19.4 – 25.3mm F/#:2.2 – 2.69	NP40ZL:	Throw Ratio: 0.79 – 1.04:1 Screen Sizes: 50" - 500"	Focal Length: 13.2 – 17.2mm F/#:2.0 -2.43
NP13ZL:	Throw Ratio: 1.46 – 2.95:1 Screen Sizes: 40" - 500"	Focal Length: 24.4 – 48.6mm F/#:1.7 – 2.37	NP41ZL:	Throw Ratio: 1.30 – 3.02:1 Screen Sizes: 50" - 500"	Focal Length: 21.8 – 49.8mm F/#:1.7 – 2.0
NP14ZL:	Throw Ratio: 2.90 -4.68:1 Screen Sizes: 60" - 500"	Focal Length: 48.5 - 77.6mm F/#:2.2 -2.64	NP42ZL:	Throw Ratio: 2.99 – 5.98:1 Screen Sizes: 50" - 500"	Focal Length: 13.2 – 17.2mm F/#:2.2 -2.3

Screen/Aspect Ratio

4:3, 16:9 and 16:10 screens are fully supported with proper aspect ratio control for both type sources using NEC developed scaling technology. Menu selections have settings for each screen type and aspect ratio control for each source type.

Notes

- For screen sizes not indicated on the projection tables, use the formulas below.
If the figures on the tables do not match the results of formulas, use the figures in the table..
- Distances are in inches, for millimeters multiply by 25.4.
- Distances may vary ±5%.

PA653U/PA803U/PA853W/PA903X Installation Guide

Desktop and Ceiling Mount

Rev 1.0

Formulas: 4:3 Aspect Ratio (PA903X—XGA)

The Projection Formulas use the image width for calculation. Image width is the same for all aspect ratios, only vertical image size varies. For proper projector placement, determine the image width for a desired screen size. Use the Screen Formulas below to calculate all screen dimensions. Plug in the image width for “W” in the Projection Formulas.

Refer to the diagrams and charts for popular screen sizes on page 2 and 3:

Projection Formulas:

- NP11FL:** C = 0.827W – 1.374
- NP12ZL:** C(Wide) = 1.214W – 1.794 ----- C(Tele) = 1.578W – 1.794
- NP13ZL:** C(Wide) = 1.525W – 1.974 ----- C(Tele) = 3.043W – 1.972
- NP14ZL:** C(Wide) = 3.034W – 4.844 ----- C(Tele) = 4.855W – 4.844
- NP30ZL:** C(Wide) = 0.827W – 1.587 ----- C(Tele) = 1.078W – 1.587
- NP40ZL:** C(Wide) = 0.824W – 1.535 ----- C(Tele) = 1.156W – 1.632
- NP41ZL:** C(Wide) = 1.354W – 1.771 ----- C(Tele) = 3.096W – 1.542
- NP42ZL:** C(Wide) = 2.993W + 5.143 ----- C(Tele) = 6.006W +4.320

Definitions:

- W = Image Width
- H = Image Height (size)
- C = Throw distance

4:3 Screen Formulas:

- W = H x 4/3
- H = W x 3/4
- Diagonal = W x 5/4

Note: Tilting the front of the projector up or down by more than 45° from level could reduce lamp life by up to 20%.

Distance Chart for popular 4:3 screens

Screen Size (4:3)			Rear Lens	Zoom Lenses							
Diagonal	Width(W)	Height (H)	NP11FL	NP30ZL	NP12ZL	NP13ZL	NP14ZL	NP40ZL	NP41ZL	NP42ZL	
inches	inches	inches	0.8:1	0.79 - 1.04:1	1.19 - 1.56:1	1.50 - 3.02:1	2.97 - 4.79:1	0.80 - 1.14:1	1.33 - 3.08:1	3.06 - 6.06:1	
			inches	inches	inches	inches	inches	inches	inches	inches	
40	32	24	25.09	24.9 - 32.9	37.1 - 48.7	46.8 - 95.4	92.2 - 150.5	24.8 - 35.4	41.6 - 97.5	100.9 - 196.5	
60	48	36	38.32	38.1 - 50.2	56.5 - 74.0	71.2 - 144.1	140.8 - 228.2	38.0 - 53.9	63.2 - 147.1	148.8 - 292.6	
67	54	40	42.95	42.7 - 56.2	63.3 - 82.8	79.8 - 161.1	157.8 - 255.4	42.6 - 60.3	70.8 - 164.4	165.6 - 326.2	
72	58	43	46.26	46.0 - 60.5	68.1 - 89.1	85.9 - 173.3	169.9 - 274.8	45.9 - 65.0	76.2 - 176.8	177.6 - 350.3	
84	67	50	54.20	54.0 - 70.9	79.8 - 104.2	100.5 - 202.5	199.0 - 321.4	53.8 - 76.1	89.2 - 206.5	206.3 - 407.9	
90	72	54	58.17	58.0 - 76.0	85.6 - 111.8	107.8 - 217.1	213.6 - 344.7	57.8 - 81.6	95.7 - 221.4	220.7 - 436.8	
100	80	60	64.79	64.6 - 84.7	95.3 - 124.4	120.0 - 241.5	237.9 - 383.6	64.4 - 90.8	106.5 - 246.1	244.6 - 484.8	
120	96	72	78.02	77.8 - 101.9	114.8 - 149.7	144.4 - 290.2	286.4 - 461.2	77.6 - 109.3	128.2 - 295.7	292.5 - 580.9	
150	120	90	NA	97.7 - 127.8	143.9 - 187.6	181.0 - 363.2	359.2 - 577.8	97.3 - 137.1	160.7 - 370.0	364.3 - 725.0	
180	144	108	NA	117.5 - 153.6	173.0 - 225.4	217.6 - 436.2	432.1 - 694.3	117.1 - 164.8	193.2 - 444.3	436.2 - 869.2	
210	168	126	NA	137.3 - 179.5	202.2 - 263.3	254.2 - 509.3	504.9 - 810.8	136.9 - 192.6	225.7 - 518.6	508.0 - 1013.3	
240	192	144	NA	157.2 - 205.4	231.3 - 301.2	290.8 - 582.3	577.7 - 927.3	156.7 - 220.3	258.2 - 592.9	579.9 - 1157.5	
270	216	162	NA	177.0 - 231.3	260.4 - 339.1	327.4 - 655.3	650.5 - 1043.8	176.4 - 248.1	290.7 - 667.2	651.7 - 1301.6	
300	240	180	NA	196.9 - 257.1	289.6 - 376.9	364.0 - 728.3	723.3 - 1160.4	196.2 - 275.8	323.2 - 741.5	723.5 - 1445.8	
400	320	240	NA	263.1 - 343.4	386.7 - 503.2	486.0 - 971.8	966.0 - 1548.8	262.1 - 368.3	431.5 - 989.2	963.0 - 1926.2	
500	400	300	NA	329.2 - 429.6	483.8 - 629.4	608.0 - 1215.2	1208.8 - 1937.2	328.1 - 460.8	539.8 - 1236.9	1202.5 - 2406.7	

PA653U/PA803U/PA853W/PA903X Installation Guide

Desktop and Ceiling Mount

Rev 1.0

Formulas: 16:10 Aspect Ratio (PA853W—WXGA)

The Projection Formulas use the image width for calculation. Image width is the same for all aspect ratios, only vertical image size varies. For proper projector placement, determine the image width for a desired screen size. Use the Screen Formulas below to calculate all screen dimensions. Plug in the image width for “W” in the Projection Formulas.

Refer to the diagrams and charts for popular screen sizes on page 2 and 3:

Projection Formulas:

- NP11FL: C = 0.812W – 1.346
- NP12ZL: C(Wide) = 1.193W – 1.795 ----- C(Tele) = 1.551W – 1.795
- NP13ZL: C(Wide) = 1.495W – 1.972 ----- C(Tele) = 2.985W – 1.972
- NP14ZL: C(Wide) = 2.976W – 4.843 ----- C(Tele) = 4.763W – 4.843
- NP30ZL: C(Wide) = 0.808W – 1.587 ----- C(Tele) = 1.054W – 1.587
- NP40ZL: C(Wide) = 0.810W – 1.535 ----- C(Tele) = 1.136W – 1.632
- NP41ZL: C(Wide) = 1.330W – 1.761 ----- C(Tele) = 3.045W – 1.539
- NP42ZL: C(Wide) = 2.941W + 5.143 ----- C(Tele) = 5.901W + 4.320

Definitions:

- W = Image Width
- H = Image Height (size)
- C = Throw distance

16:10 Screen Formulas:

- W = H x 16/10
- H = W x 10/16
- Screen Diagonal = W x 18.868/16

Distance Chart for popular 16:10 Screens (WXGA)

Screen Size (16:10)			Rear Lens	Zoom Lenses							
Diagonal	Width(W)	Height (H)	NP11FL	NP30ZL	NP12ZL	NP13ZL	NP14ZL	NP40ZL	NP41ZL	NP42ZL	
inches	inches	inches	0.8:1	0.79 - 1.04:1	1.19 - 1.56:1	1.50 - 3.02:1	2.97 - 4.79:1	0.79 - 1.12:1	1.31 - 3.03:1	3.00 - 5.95:1	
40	34	21	26.3	25.9 - 34.3	38.8 - 50.9	48.9 - 99.5	96.3 - 157.1	26.0 - 37.0	43.5 - 102.0	105.1 - 205.0	
60	51	32	40.1	39.7 - 52.2	59.0 - 77.3	74.3 - 150.3	146.9 - 238.1	39.8 - 56.3	66.1 - 153.8	155.1 - 305.3	
67	57	36	44.9	44.5 - 58.5	66.2 - 86.6	83.2 - 168.2	164.8 - 266.6	44.6 - 63.1	74.0 - 172.0	172.8 - 340.7	
72	61	38	48.2	47.8 - 62.8	71.0 - 92.8	89.2 - 180.1	176.7 - 285.7	47.9 - 67.7	79.4 - 184.2	184.5 - 364.3	
84	71	45	56.3	55.8 - 73.3	82.9 - 108.3	104.2 - 210.0	206.5 - 333.3	56.0 - 79.0	92.7 - 214.7	214.0 - 423.3	
90	76	48	60.4	59.9 - 78.6	88.9 - 116.1	111.6 - 224.9	221.3 - 357.1	60.0 - 84.7	99.3 - 229.9	228.7 - 452.8	
100	85	53	67.7	67.1 - 88.1	99.6 - 130.0	125.1 - 251.8	248.1 - 400.0	67.3 - 94.9	111.3 - 257.3	255.1 - 505.9	
120	102	64	81.5	80.9 - 106.0	119.9 - 156.4	150.5 - 302.5	298.7 - 481.0	81.1 - 114.2	133.9 - 309.1	305.1 - 606.2	
150	127	79	NA	101.1 - 132.3	149.7 - 195.2	187.9 - 377.1	373.1 - 600.1	101.3 - 142.6	167.1 - 385.2	378.7 - 753.7	
180	153	95	NA	122.1 - 159.7	180.7 - 235.5	226.8 - 454.7	450.5 - 723.9	122.4 - 172.2	201.7 - 464.3	455.1 - 907.2	
210	178	111	NA	142.3 - 186.1	210.6 - 274.3	264.1 - 529.4	524.9 - 843.0	142.6 - 200.6	235.0 - 540.5	528.6 - 1054.7	
240	204	127	NA	163.3 - 213.5	241.6 - 314.6	303.0 - 607.0	602.3 - 966.8	163.7 - 230.1	269.6 - 619.6	605.1 - 1208.1	
270	229	143	NA	183.5 - 239.8	271.4 - 353.4	340.4 - 681.6	676.7 - 1085.9	184.0 - 258.5	302.8 - 695.8	678.6 - 1355.6	
300	254	159	NA	203.7 - 266.2	301.2 - 392.2	377.8 - 756.2	751.1 - 1205.0	204.2 - 286.9	336.1 - 771.9	752.2 - 1503.2	
400	339	212	NA	272.4 - 355.8	402.6 - 524.0	504.8 - 1009.9	1004.0 - 1609.8	273.1 - 383.5	449.1 - 1030.7	1002.1 - 2004.8	
500	424	265	NA	341.1 - 445.4	504.0 - 655.8	631.9 - 1263.7	1257.0 - 2014.7	341.9 - 480.0	562.2 - 1289.5	1252.1 - 2506.3	

PA653U/PA803U/PA853W/PA903X Installation Guide

Desktop and Ceiling Mount

Rev 1.0

Formulas: 16:10 Aspect Ratio (PA653U/PA803U—WUXGA)

The Projection Formulas use the image width for calculation. Image width is the same for all aspect ratios, only vertical image size varies. For proper projector placement, determine the image width for a desired screen size. Use the Screen Formulas below to calculate all screen dimensions. Plug in the image width for “W” in the Projection Formulas.

Refer to the diagrams and charts for popular screen sizes on page 2 and 3:

Projection Formulas:

- NP11FL: C = 0.807W – 1.354
- NP12ZL: C(Wide) = 1.185W – 1.794 ----- C(Tele) = 1.541W – 1.794
- NP13ZL: C(Wide) = 1.488W – 1.974 ----- C(Tele) = 2.970W – 1.972
- NP14ZL: C(Wide) = 2.961W – 4.844 ----- C(Tele) = 4.737W – 4.844
- NP30ZL: C(Wide) = 0.808W – 1.537 ----- C(Tele) = 1.054W – 1.537
- NP40ZL: C(Wide) = 0.807W – 1.535 ----- C(Tele) = 1.131W – 1.632
- NP41ZL: C(Wide) = 1.323W – 1.763 ----- C(Tele) = 3.034W – 1.539
- NP42ZL: C(Wide) = 2.929W + 5.143 ----- C(Tele) = 5.878W + 4.320

Definitions:

- W = Image Width
- H = Image Height (size)
- C = Throw distance

16:10 Screen Formulas

- W = H x 16/10
- H = W x 10/16
- Screen Diagonal = W x 18.868/16

Distance Chart for popular 16:10 Screens (WUXGA)

Screen Size (16:10)			Rear Lens	Zoom Lenses						
Diagonal	Width(W)	Height (H)	NP11FL	NP30ZL	NP12ZL	NP13ZL	NP14ZL	NP40ZL	NP41ZL	NP42ZL
inches	inches	inches	0.8:1	0.79 - 1.04:1	1.19 - 1.56:1	1.50 - 3.02:1	2.97 - 4.79:1	0.79 - 1.11:1	1.30 - 3.02:1	2.88 - 5.72:1
			inches	inches	inches	inches	inches	inches	inches	inches
40	34	21	26.08	25.9 - 34.3	38.5 - 50.6	48.6 - 99.0	95.8 - 156.2	25.9 - 36.8	43.2 - 101.6	104.7 - 204.2
60	51	32	39.80	39.7 - 52.2	58.6 - 76.8	73.9 - 149.5	146.2 - 236.7	39.6 - 56.0	65.7 - 153.2	154.5 - 304.1
67	57	36	44.65	44.5 - 58.5	65.8 - 86.0	82.8 - 167.3	163.9 - 265.2	44.5 - 62.8	73.6 - 171.4	172.1 - 339.4
72	61	38	47.87	47.8 - 62.8	70.5 - 92.2	88.8 - 179.2	175.8 - 284.1	47.7 - 67.4	78.9 - 183.5	183.8 - 362.9
84	71	45	55.94	55.8 - 73.3	82.3 - 107.6	103.7 - 208.9	205.4 - 331.5	55.8 - 78.7	92.2 - 213.9	213.1 - 421.7
90	76	48	59.98	59.9 - 78.6	88.3 - 115.3	111.1 - 223.7	220.2 - 355.2	59.8 - 84.3	98.8 - 229.0	227.7 - 451.0
100	85	53	67.24	67.1 - 88.1	98.9 - 129.2	124.5 - 250.5	246.8 - 397.8	67.1 - 94.5	110.7 - 256.4	254.1 - 504.0
120	102	64	80.96	80.9 - 106.0	119.1 - 155.4	149.8 - 301.0	297.2 - 478.3	80.8 - 113.7	133.2 - 307.9	303.9 - 603.9
150	127	79	NA	101.1 - 132.3	148.7 - 193.9	187.0 - 375.2	371.2 - 596.8	101.0 - 142.0	166.3 - 383.8	377.1 - 750.8
180	153	95	NA	122.1 - 159.7	179.5 - 234.0	225.7 - 452.4	448.2 - 719.9	121.9 - 171.4	200.7 - 462.7	453.3 - 903.7
210	178	111	NA	142.3 - 186.1	209.1 - 272.5	262.9 - 526.7	522.2 - 838.3	142.1 - 199.7	233.7 - 538.5	526.5 - 1050.6
240	204	127	NA	163.3 - 213.5	239.9 - 312.6	301.6 - 603.9	599.2 - 961.5	163.1 - 229.1	268.1 - 617.4	602.7 - 1203.4
270	229	143	NA	183.5 - 239.8	269.6 - 351.1	338.8 - 678.2	673.2 - 1079.9	183.3 - 257.4	301.2 - 693.2	675.9 - 1350.4
300	254	159	NA	203.7 - 266.2	299.2 - 389.6	376.0 - 752.4	747.3 - 1198.4	203.4 - 285.6	334.3 - 769.1	749.1 - 1497.3
400	339	212	NA	272.4 - 355.8	399.9 - 520.6	502.5 - 1004.9	998.9 - 1601.0	272.0 - 381.8	446.7 - 1027.0	998.1 - 1997.0
500	424	265	NA	341.1 - 445.4	500.6 - 651.6	628.9 - 1257.3	1250.6 - 2003.6	340.6 - 477.9	559.2 - 1284.9	1247.0 - 2496.6

Note: For screen sizes not indicated in projection tables, refer to formulas above respective charts.

PA653U/PA803U/PA853W/PA903X Installation Guide

Desktop and Ceiling Mount

Rev 1.0

Ceiling Mount Installation

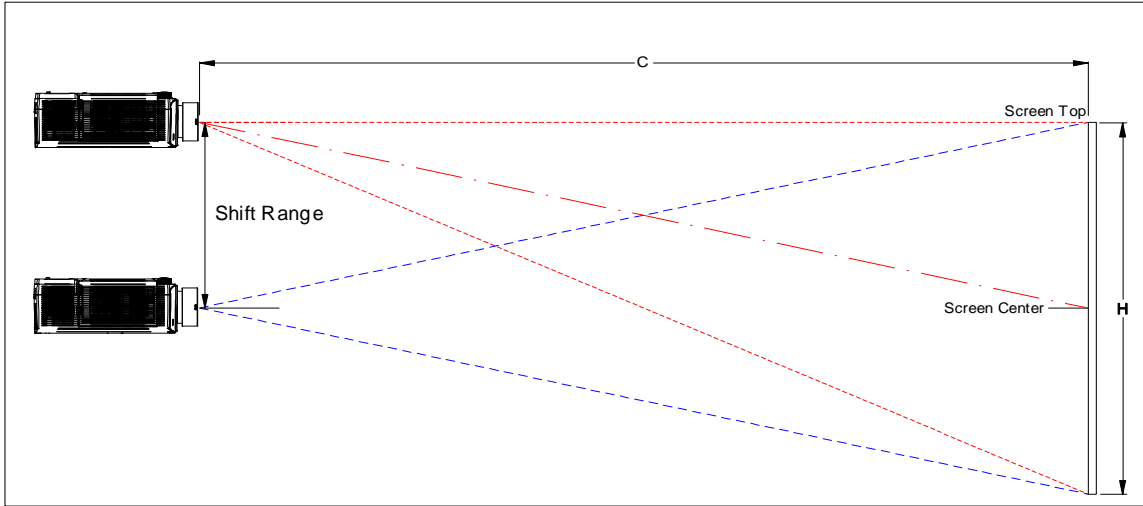

Desktop Installation

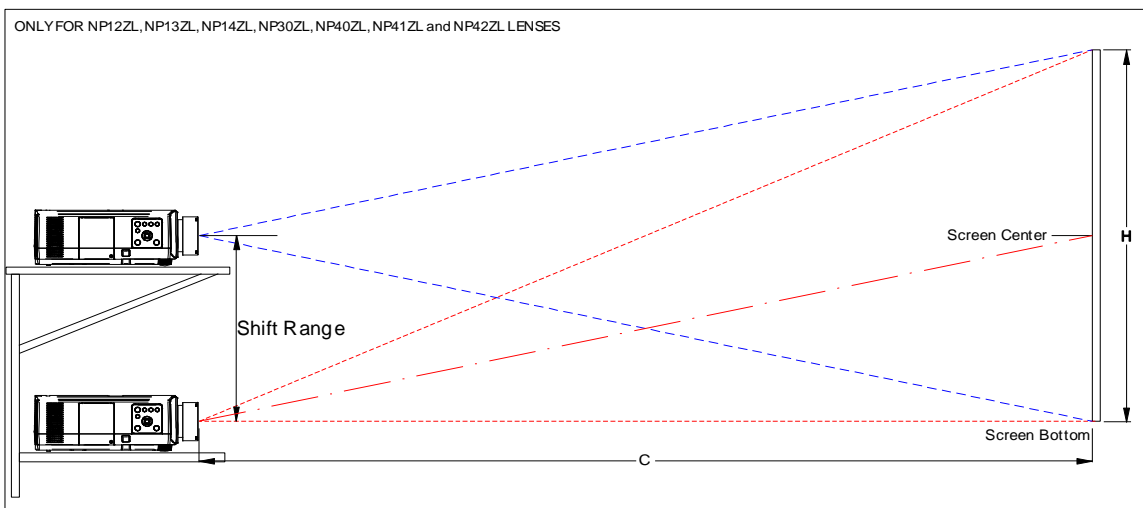

Note: Lens Shift Feature is not available to NP11FL. This lens should only be used for "zero degree"/"no-offset" applications. See below

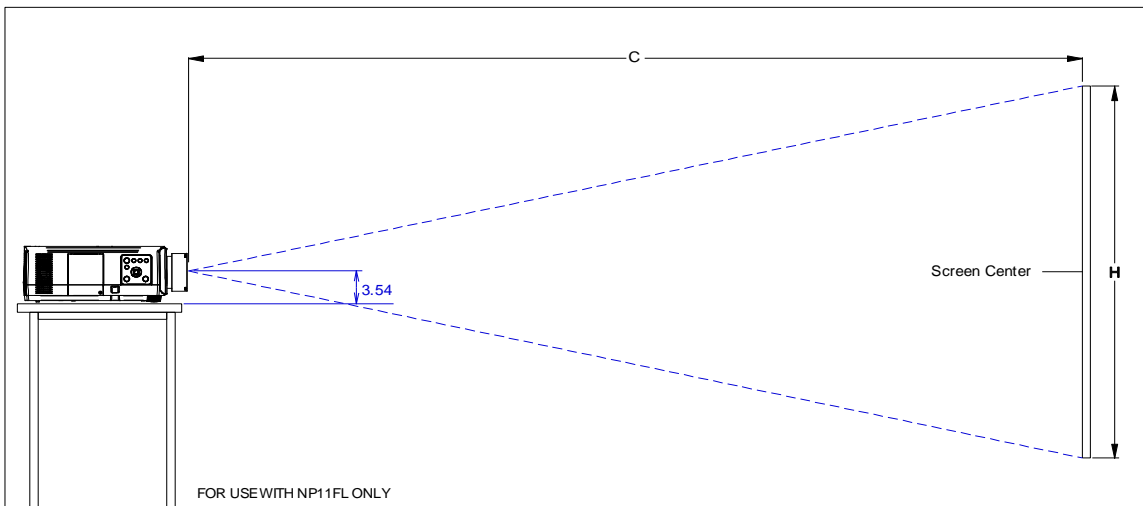

PA653U/PA803U/PA853W/PA903X Installation Guide

Desktop and Ceiling Mount

Rev 1.0

Lens Shift Adjustable Range

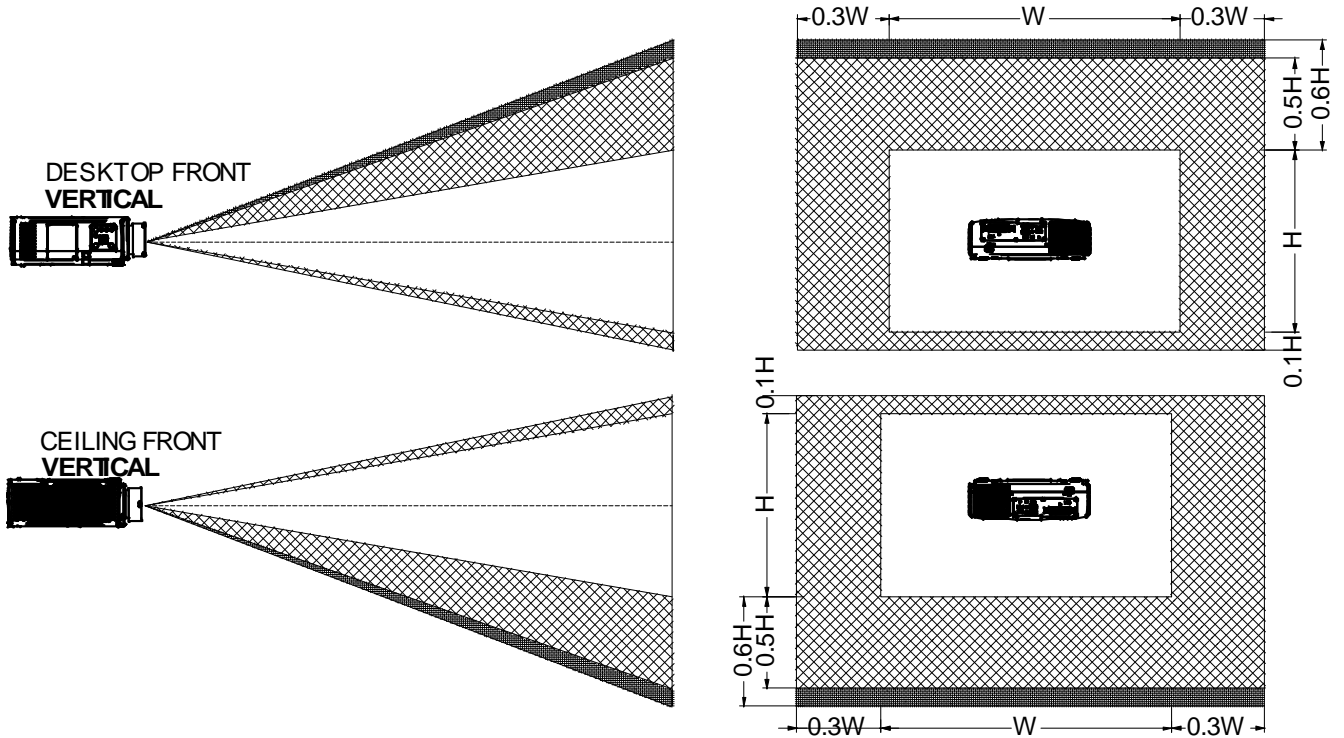

Lens Shift Range for Desktop and Ceiling Mount Application

The diagram below shows the location of the image position in the lens. The lens can be shifted within the shaded area as shown using the normal projection position as a starting point.

Note: Lens shift feature is not available with NP11FL (rear lens). NP11FL should be used only for "zero degree" / "no-offset" applications.

Maximum Possible Range for NP12ZL, NP13ZL, NP14ZL, NP30ZL, NP40ZL, NP41ZL, NP42ZL:

Towards ceiling/floor: 0.5H (0.6H for PA853W)

Away from ceiling/floor: 0.1H

Right: 0.3W

Left: 0.3W

(W: width of projected image, H: height of projected image)

Note: Horizontal lens shift range for the PA653U and PA803U is 0.15W at a 200" projected image with NP41ZL

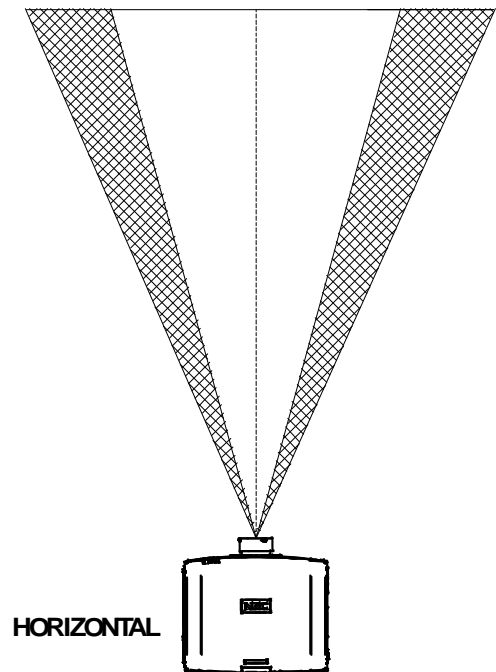

PA653U/PA803U/PA853W/PA903X Installation Guide

Desktop and Ceiling Mount

Rev 1.0

Cabinet Dimensions

The following diagrams show the cabinet dimensions for the PA653U/ PA803U/PA853W/PA903X. Dimensions are in inches. For millimeters multiply by 25.4.

Note: Dimensions below shown with the NP41ZL lens

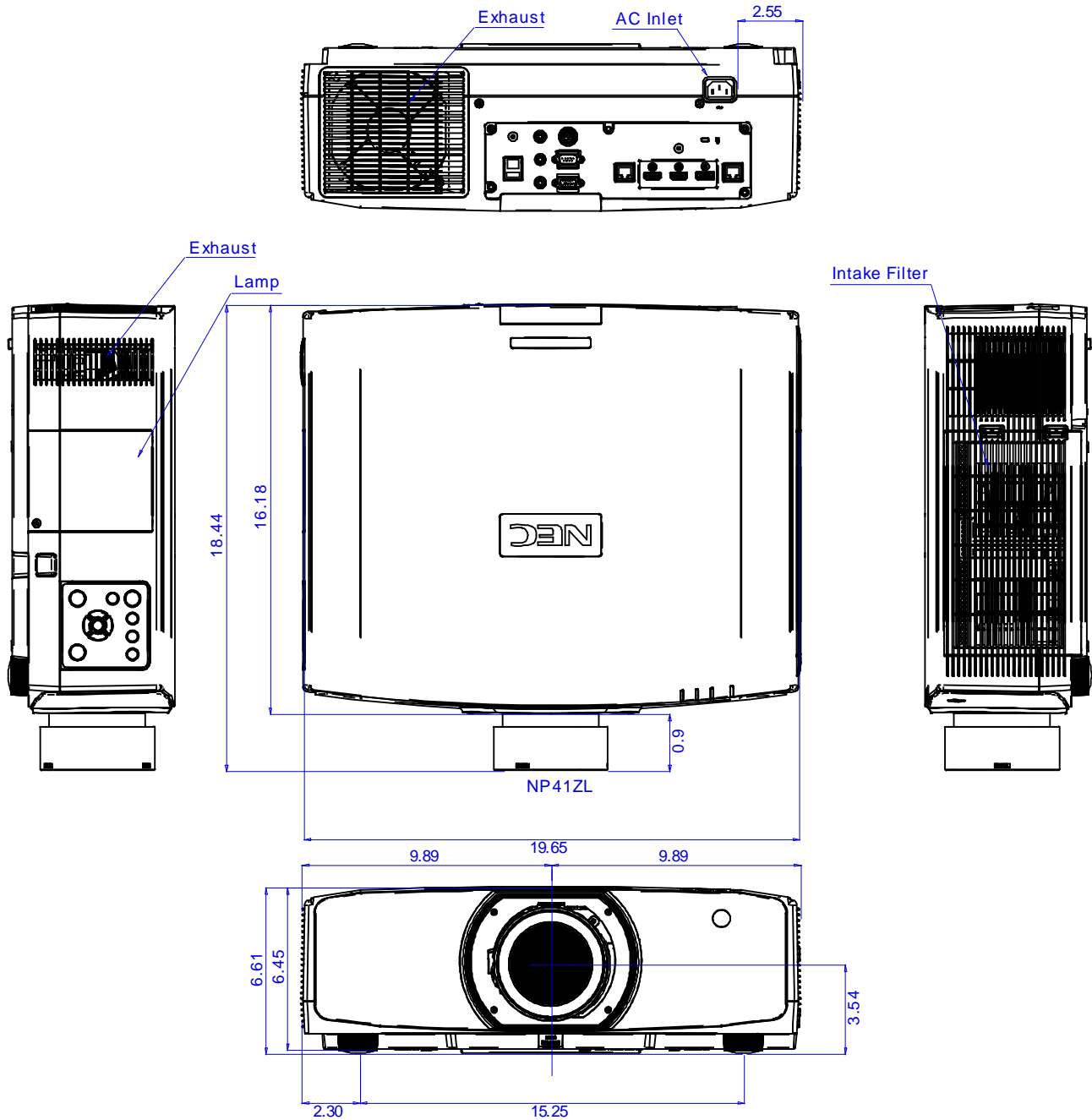

PA653U/PA803U/PA853W/PA903X Installation Guide

Desktop and Ceiling Mount

Rev 1.0

Cabinet Dimensions

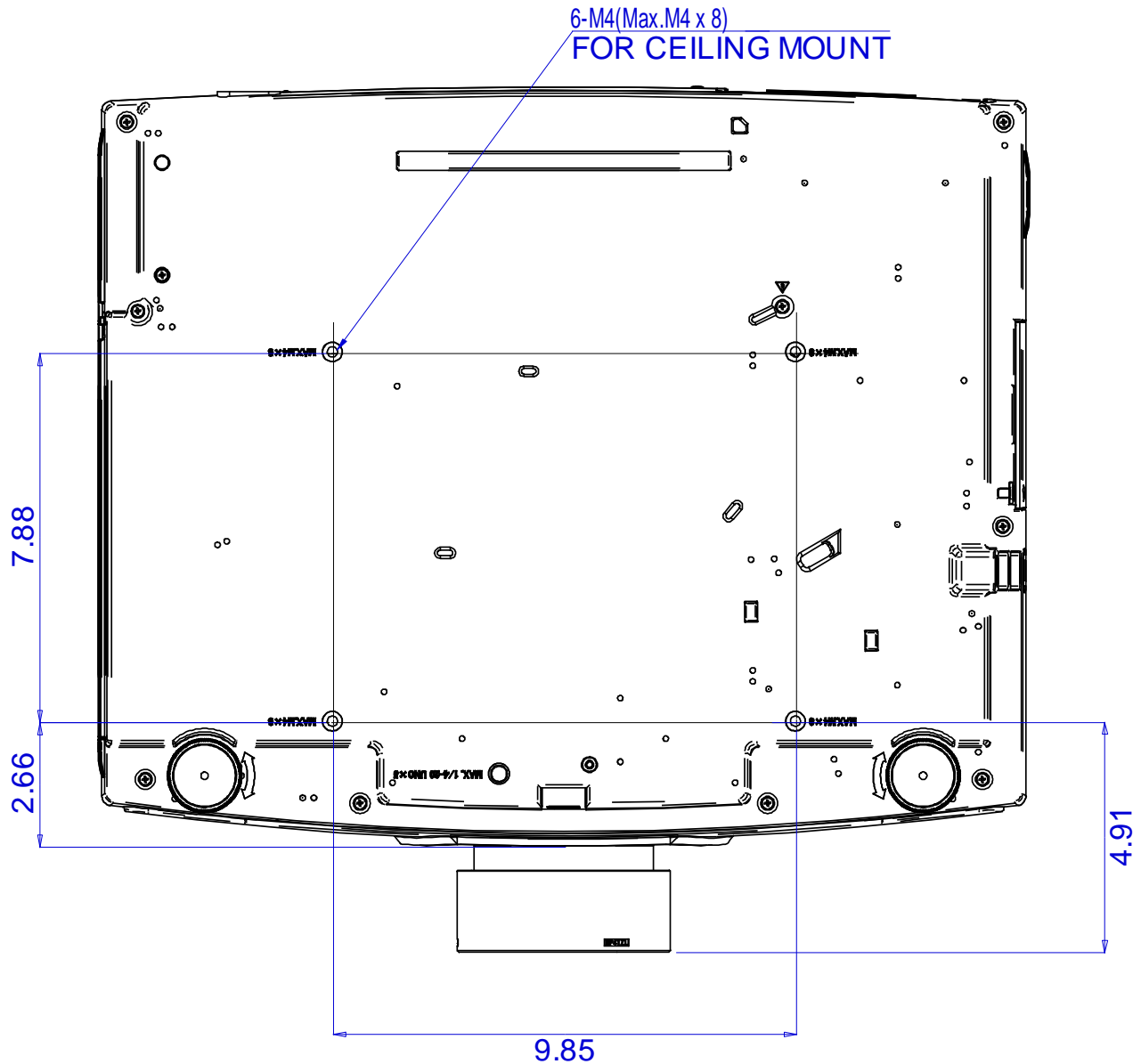

PA653U/PA803U/PA853W/PA903X Installation Guide

Desktop and Ceiling Mount

Rev 1.0

Optional Lens Dimensions (NP11FL and NP12ZL)

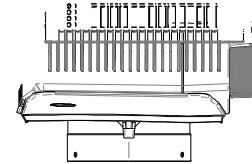
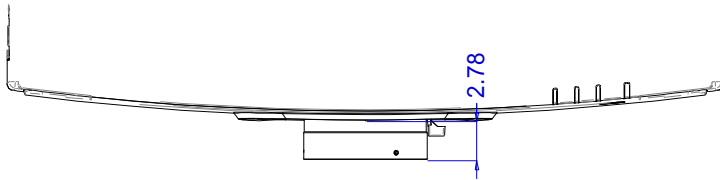

NP11FL

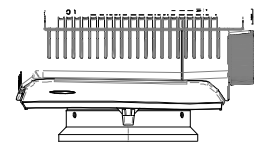
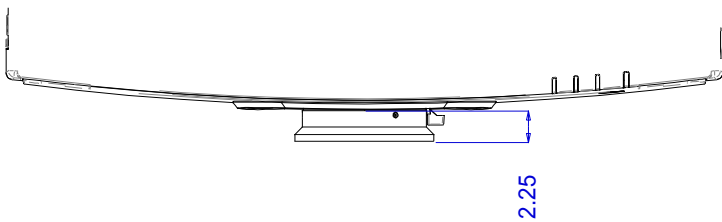
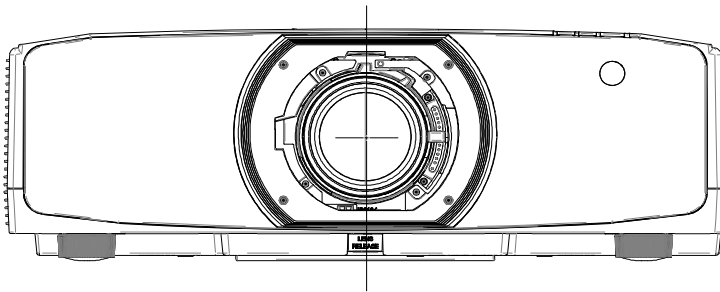

NP12ZL

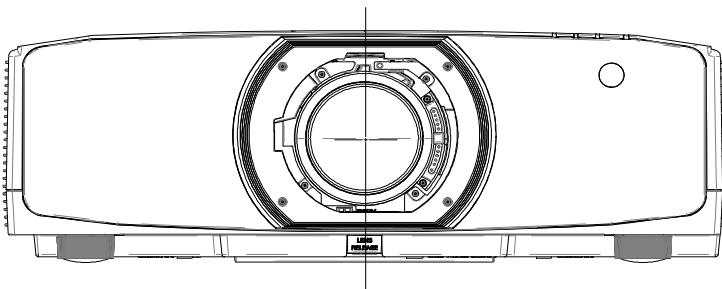

PA653U/PA803U/PA853W/PA903X Installation Guide

Desktop and Ceiling Mount

Rev 1.0

Optional Lens Dimensions (NP13ZL and NP14ZL)

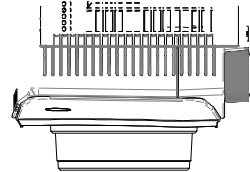
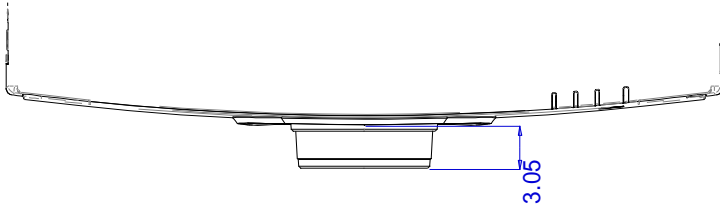

NP13ZL

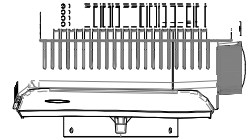
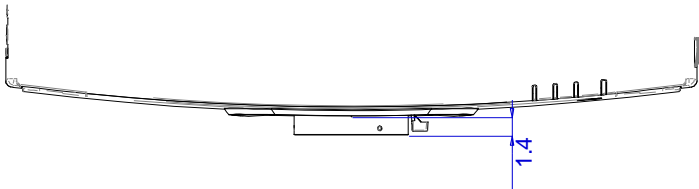
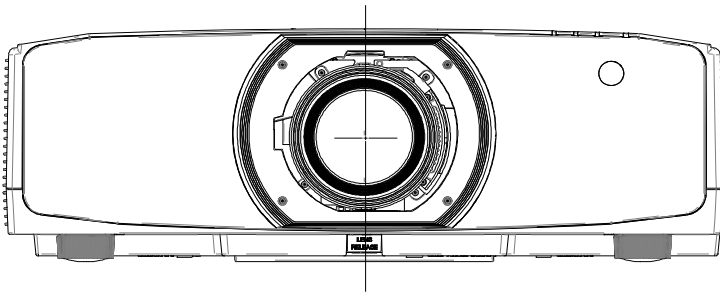

NP14ZL

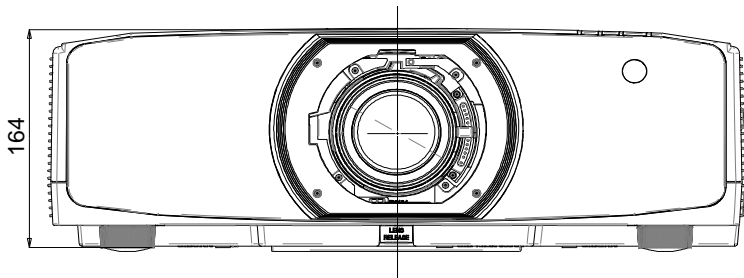

PA653U/PA803U/PA853W/PA903X Installation Guide

Desktop and Ceiling Mount

Rev 1.0

Optional Lens Dimensions (NP30ZL and NP40ZL)

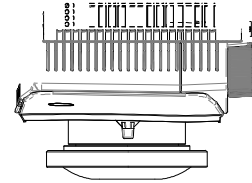
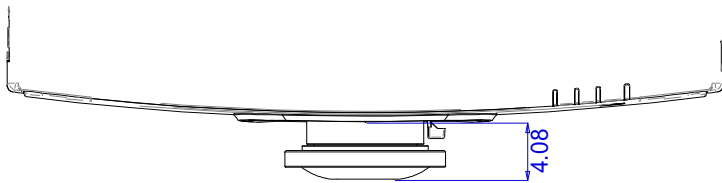

NP30ZL

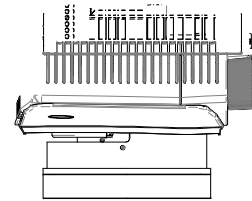
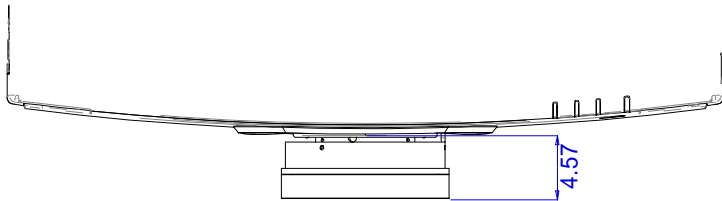
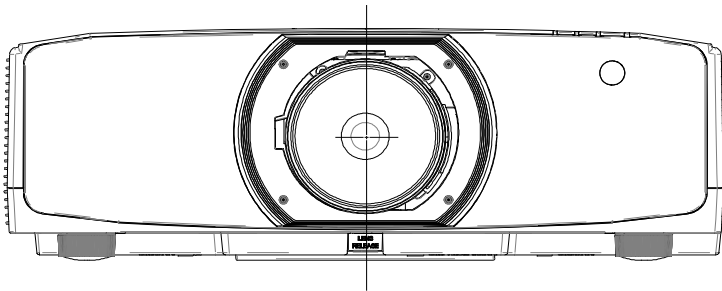

NP40ZL

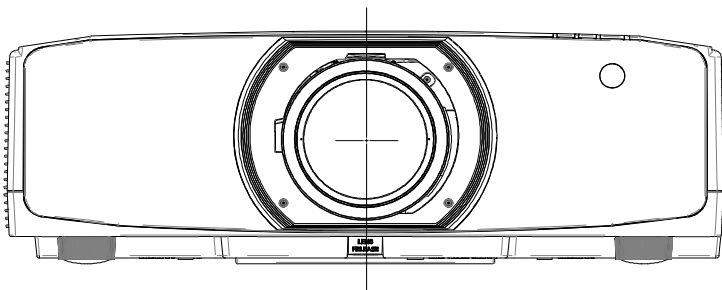

PA653U/PA803U/PA853W/PA903X Installation Guide

Desktop and Ceiling Mount

Rev 1.0

Optional Lens Dimensions (NP42ZL)

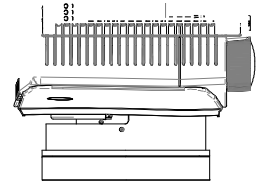
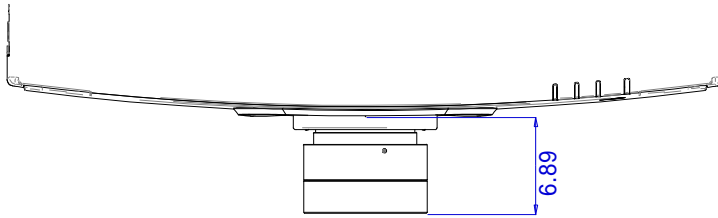

NP42ZL

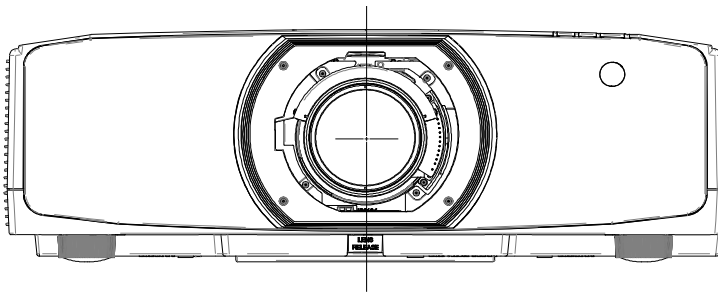

PA653U/PA803U/PA853W/PA903X Installation Guide

Desktop and Ceiling Mount

Rev 1.0

Optional Ceiling Mount Dimensions (Part #: NP600CM)

The following diagrams show ceiling mount dimensions for the NP600CM. Dimensions are in inches. For millimeters multiply by 25.4.

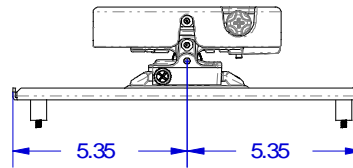
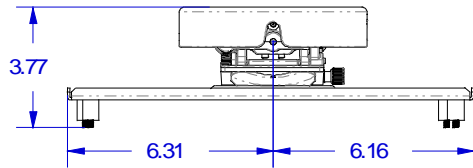
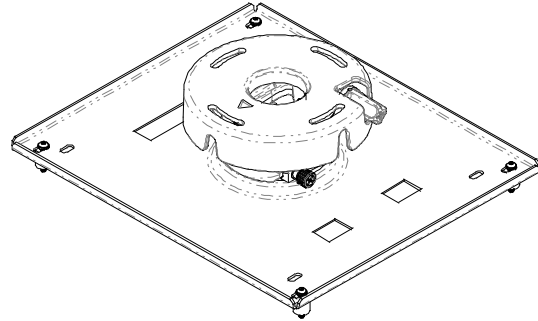
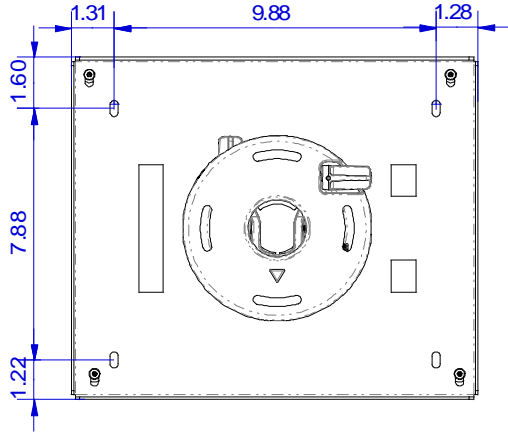

Input Panel



PA653U/PA803U/PA853W/PA903X Installation Guide

Desktop and Ceiling Mount

Rev 1.0

PC Control Codes

Function	Code Data										
POWER ON	02H	00H	00H	00H	00H	02H					
POWER OFF	02H	01H	00H	00H	00H	03H					
INPUT SELECT HDMI1	02H	03H	00H	00H	02H	01H	A1H	A9H			
INPUT SELECT HDMI2	02H	03H	00H	00H	02H	01H	A2H	AAH			
INPUT SELECT DisplayPort	02H	03H	00H	00H	02H	01H	A6H	AEH			
INPUT SELECT Computer	02H	03H	00H	00H	02H	01H	01H	09H			
INPUT SELECT HDBaseT	02H	03H	00H	00H	02H	01H	BFH	C7H			
PICTURE MUTE ON	02H	10H	00H	00H	00H	12H					
PICTURE MUTE OFF	02H	11H	00H	00H	00H	13H					
SOUND MUTE ON	02H	12H	00H	00H	00H	14H					
SOUND MUTE OFF	02H	13H	00H	00H	00H	15H					
ON SCREEN MUTE ON	02H	14H	00H	00H	00H	16H					
ON SCREEN MUTE OFF	02H	15H	00H	00H	00H	17H					
ASPECT RATIO (4:3 Screen)											
4:3	03H	10H	00H	00H	05H	18H	00H	00H	00H	00H	30H
LETTERBOX	03H	10H	00H	00H	05H	18H	00H	00H	01H	00H	31H
WIDESCREEN	03H	10H	00H	00H	05H	18H	00H	00H	02H	00H	32H
ZOOM	03H	10H	00H	00H	05H	18H	00H	00H	03H	00H	33H
ASPECT RATIO (RGB)											
4:3 WINDOW	03H	10H	00H	00H	05H	18H	00H	00H	00H	00H	30H
16:9	03H	10H	00H	00H	05H	18H	00H	00H	02H	00H	32H
5:4	03H	10H	00H	00H	05H	18H	00H	00H	0BH	00H	3BH
16:10	03H	10H	00H	00H	05H	18H	00H	00H	0CH	00H	3CH
15:9	03H	10H	00H	00H	05H	18H	00H	00H	0DH	00H	3DH
AUTO ADJUST	02H	0FH	00H	00H	02H	05H	00H	18H			

Cable Connection

Communication Protocol:

Baud Rate: 38400 bps (for cable lengths longer than 20', it is recommended changing to 9600 bps in setup menu)
 Data Length: 8 bits
 Parity: No Parity
 Stop Bit: One bit
 X on/off: None
 Communications: Full duplex

PC Control Connector (D-Sub 9P)

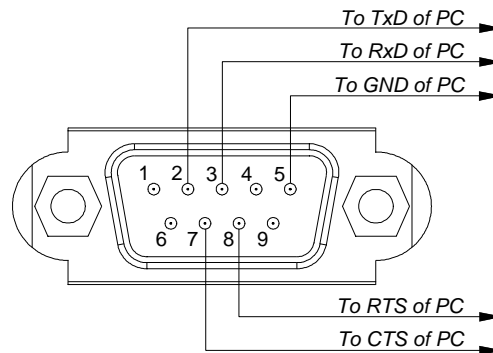

NOTE 1 : Pins 1, 4, 6, and 9 are used inside the projector.

NOTE 2 : For long cable runs it is recommended to set communication speed within the projector to 9600 bps.

NOTE 3 : Jumper "Request to Send" and "Clear to Send" together on both ends of the cable to simplify cable connection.