

# Precision 3480

## Owner's Manual

## Notes, cautions, and warnings

 **NOTE:** A NOTE indicates important information that helps you make better use of your product.

 **CAUTION:** A CAUTION indicates either potential damage to hardware or loss of data and tells you how to avoid the problem.

 **WARNING:** A WARNING indicates a potential for property damage, personal injury, or death.

<b>Chapter 1: Views of Precision 3480</b>	<b>7</b>
Right	7
Left	7
Top	9
Display	10
Bottom	11
Service Tag	11
Battery charge and status light	12
<b>Chapter 2: Set up your Precision 3480</b>	<b>13</b>
<b>Chapter 3: Specifications of Precision 3480</b>	<b>15</b>
Dimensions and weight	15
Processor	15
Chipset	17
Operating system	17
Memory	17
External ports	18
Internal slots	18
Ethernet	19
Wireless module	19
WWAN module	19
Audio	21
Storage	21
Keyboard	21
Keyboard function keys	22
Camera	23
Touchpad	24
Power adapter	24
Battery	25
Display	26
Fingerprint reader (optional)	27
Sensor	28
GPU—Integrated	28
GPU—Discrete	28
External display support	28
Hardware security	28
Smart-card reader	29
Contactless smart-card reader	29
Contacted smart-card reader	30
Operating and storage environment	31
Dell Support policy	32
ComfortView Plus	32
Using the privacy shutter	32

Dell Optimizer.....	33
---------------------	----

**Chapter 4: Working inside your computer..... 34**

Safety instructions.....	34
Before working inside your computer.....	34
Safety precautions.....	35
Electrostatic discharge—ESD protection.....	35
ESD field service kit .....	36
Transporting sensitive components.....	37
After working inside your computer.....	37
BitLocker.....	37
Recommended tools.....	37
Screw list.....	38
Major components of Precision 3480.....	39

**Chapter 5: Removing and installing Customer Replaceable Units (CRUs)..... 41**

SIM card tray.....	41
Removing the SIM card tray.....	41
Installing the SIM card tray.....	42
Base cover.....	43
Removing the base cover.....	43
Installing the base cover.....	45
Memory modules.....	46
Removing the memory module.....	46
Installing the memory module.....	47
Solid-state drive.....	48
Removing the M.2 2230 solid-state drive.....	48
Installing the M.2 2230 solid-state drive.....	48
Wireless card.....	49
Removing the wireless card.....	49
Installing the wireless card.....	50
Wireless Wide Area Network (WWAN) card.....	52
Removing the WWAN card.....	52
Installing the WWAN card.....	54
Fan.....	57
Removing the fan.....	57
Installing the fan.....	58

**Chapter 6: Removing and installing Field Replaceable Units (FRUs)..... 60**

Battery.....	60
Lithium-ion battery precautions.....	60
Removing the battery.....	60
Installing the battery.....	61
Coin-cell battery.....	62
Removing the coin-cell battery.....	62
Installing the coin-cell battery.....	63
Heat sink.....	64
Removing the heat sink - for computers shipped with integrated graphics card.....	64
Installing the heat sink - for computers shipped with integrated graphics card.....	67

Removing the heat sink - for computers shipped with discrete graphics card.....	69
Installing the heat sink - for computers shipped with discrete graphics card.....	70
Speakers.....	71
Removing the speakers.....	71
Installing the speakers.....	72
Assembly inner frame.....	73
Removing the assembly inner frame.....	73
Installing the assembly inner frame.....	74
Display assembly.....	75
Removing the display assembly.....	75
Installing the display assembly.....	79
Display bezel.....	84
Removing the display bezel.....	84
Installing the display bezel.....	84
Display panel.....	85
Removing the display panel.....	85
Installing the display panel.....	87
Camera module.....	89
Removing the camera module.....	89
Installing the camera module.....	90
Display hinges.....	91
Removing the display hinges.....	91
Installing the display hinges.....	91
Display cable.....	92
Removing the display cable.....	92
Installing the display cable.....	94
Display back cover.....	96
Removing the display back cover.....	96
Installing the display back cover.....	97
System board.....	98
Removing the system board.....	98
Installing the system board.....	100
Smart card reader.....	102
Removing the smart card reader.....	102
Installing the smart card reader.....	103
Power-button board.....	104
Removing the power-button board.....	104
Installing the power-button board.....	105
Keyboard.....	107
Removing the keyboard.....	107
Installing the keyboard.....	109
Palm-rest assembly.....	110
Removing the palm-rest assembly.....	110
Installing the palm-rest assembly.....	111
Dummy SIM-card slot filler.....	112
Removing the dummy SIM-card slot filler.....	112
Installing the dummy SIM-card slot filler.....	113
<b>Chapter 7: Software.....</b>	<b>115</b>
Operating system.....	115

Drivers and downloads.....	115
<b>Chapter 8: BIOS setup.....</b>	<b>116</b>
Entering BIOS setup program.....	116
Navigation keys.....	116
One Time Boot menu.....	116
System setup options.....	117
Updating the BIOS.....	127
Updating the BIOS in Windows.....	127
Updating the BIOS in Linux and Ubuntu.....	127
Updating the BIOS using the USB drive in Windows.....	127
Updating the BIOS from the F12 One-Time boot menu.....	128
System and setup password.....	128
Assigning a system setup password.....	128
Deleting or changing an existing system setup password.....	129
Clearing CMOS settings.....	129
Clearing BIOS (System Setup) and System passwords.....	130
Clearing Chassis Intrusion Alert.....	130
<b>Chapter 9: Troubleshooting.....</b>	<b>133</b>
Handling swollen Lithium-ion batteries.....	133
<b>Locate the Service Tag or Express Service Code of your Dell computer</b> .....	133
Dell SupportAssist Pre-boot System Performance Check diagnostics.....	134
Running the SupportAssist Pre-Boot System Performance Check.....	134
Built-in self-test (BIST).....	134
M-BIST.....	134
LCD Power rail test (L-BIST).....	135
LCD Built-in Self Test (BIST).....	135
System-diagnostic lights.....	136
Recovering the operating system.....	137
Real-Time Clock (RTC Reset).....	137
Backup media and recovery options.....	137
Wi-Fi power cycle.....	137
Drain residual flea power (perform hard reset).....	137
<b>Chapter 10: Getting help and contacting Dell.....</b>	<b>139</b>

# Views of Precision 3480

## Right



### 1. Universal audio jack

Connect headphones or a headset (headphone and microphone combo).

### 2. USB 3.2 Gen 1 port with PowerShare

Connect devices such as external storage devices and printers.

Provides data transfer speeds up to 5 Gbps. PowerShare enables you to charge your USB devices even when your computer is turned off.

**NOTE:** If your computer is turned off or in hibernate state, you must connect the power adapter to charge your devices using the PowerShare port. You must enable this feature in the BIOS setup program.

**NOTE:** Certain USB devices may not charge when the computer is turned off or in sleep state. In such cases, turn on the computer to charge the device.

### 3. HDMI port

Connect to a TV, external display or another HDMI-in enabled device. Provides video and audio output.

### 4. Security-cable slot

Connect a security cable to prevent unauthorized movement of your computer.

## Left

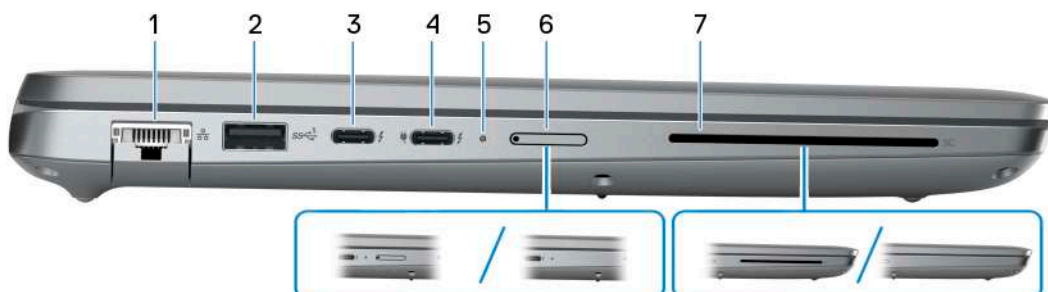

### 1. Network port

Connect an Ethernet (RJ45) cable from a router or a broadband modem for network or Internet access, with a transfer rate of 10/100/1000 Mbps.

## 2. USB 3.2 Gen 1 port

Connect devices such as external storage devices and printers. Provides data transfer speeds up to 5 Gbps.

## 3. Thunderbolt 4.0 with DisplayPort Alt Mode/USB Type-C/USB4/Power Delivery

Supports USB4, DisplayPort 1.4, Thunderbolt 4 and also enables you to connect to an external display using a display adapter. Provides data transfer rates of up to 40 Gbps for USB4 and Thunderbolt 4.

**NOTE:** You can connect a Dell Docking Station to the Thunderbolt 4 ports. For more information, search in the Knowledge Base Resource at [www.dell.com/support](http://www.dell.com/support).

**NOTE:** A USB Type-C to DisplayPort adapter (sold separately) is required to connect a DisplayPort device.

**NOTE:** USB4 is backward compatible with USB 3.2, USB 2.0, and Thunderbolt 3.

**NOTE:** Thunderbolt 4 supports two 4K displays or one 8K display.

## 4. Thunderbolt 4.0 with DisplayPort Alt Mode/USB Type-C/USB4/Power Delivery

Supports USB4, DisplayPort 1.4, Thunderbolt 4 and also enables you to connect to an external display using a display adapter. Provides data transfer rates of up to 40 Gbps for USB4 and Thunderbolt 4.

**NOTE:** You can connect a Dell Docking Station to the Thunderbolt 4 ports. For more information, search in the Knowledge Base Resource at [www.dell.com/support](http://www.dell.com/support).

**NOTE:** A USB Type-C to DisplayPort adapter (sold separately) is required to connect a DisplayPort device.

**NOTE:** USB4 is backward compatible with USB 3.2, USB 2.0, and Thunderbolt 3.

**NOTE:** Thunderbolt 4 supports two 4K displays or one 8K display.

## 5. Power and battery-status light

Indicates the power state and battery state of the computer.

Solid white—Power adapter is connected and the battery is charging.

Solid amber—Battery charge is low or critical.

Off—Battery is fully charged.

**NOTE:** On certain computer models, the power and battery-status light are also used for diagnostics. For more information, see the *Troubleshooting* section in your computer's *Service Manual*.

## 6. nano-SIM slot (optional)

Insert a nano-SIM card to connect to a mobile broadband network.

## 7. Smart-card reader (optional)

Using smart card provides authentication in corporate networks.



# Top



## 1. Touchpad

Move your finger on the touchpad to move the mouse pointer. Tap to left-click and two fingers tap to right-click.

## 2. NFC/Contactless smart card reader (optional)

Provides contactless access of cards in corporate networks.

## 3. Power button with optional fingerprint reader

Press to turn on the computer if it is turned off, in sleep state, or in hibernate state.

When the computer is turned on, press the power button to put the computer into sleep state; press and hold the power button for 10 seconds to force shut-down the computer.

If the power button has a fingerprint reader, place your finger on the power button steadily to log in.

**i NOTE:** The power-status light on the power button is available only on computers without the fingerprint reader. Computers that are shipped with the fingerprint reader that is integrated on the power button will not have the power-status light on the power button.

**i NOTE:** You can customize the power-button behavior in Windows.

# Display



**1. Left microphone**

Provides digital sound input for audio recording and voice calls.

**2. Infrared emitter (optional)**

Emits infrared light, which enables the infrared camera to sense and track motion.

**3. Infrared camera (optional)**

Enhances security when paired with Windows Hello face authentication.

**4. Camera shutter**

Slide the camera shutter to turn the camera on or off.

**5. Camera**

Enables you to video chat, capture photos, and record videos.

**6. Camera-status light**

Turns on when the camera is in use.

**7. Ambient-light sensor**

The sensor detects the ambient light and automatically adjusts the display brightness.

**8. Right microphone**

Provides digital sound input for audio recording and voice calls.

## Bottom

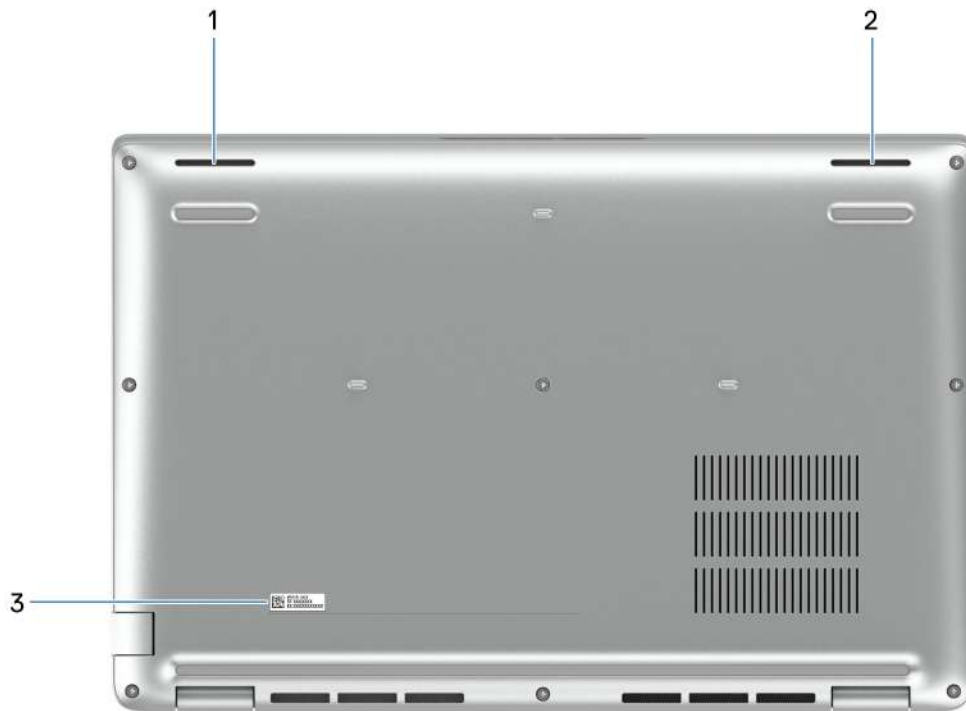

**1. Left speaker**

Provides audio output.

**2. Right speaker**

Provides audio output.

**3. Service Tag label**

The Service Tag is a unique alphanumeric identifier that enables Dell service technicians to identify the hardware components in your computer and access warranty information.

## Service Tag

The service tag is a unique alphanumeric identifier that allows Dell service technicians to identify the hardware components in your computer and access warranty information.

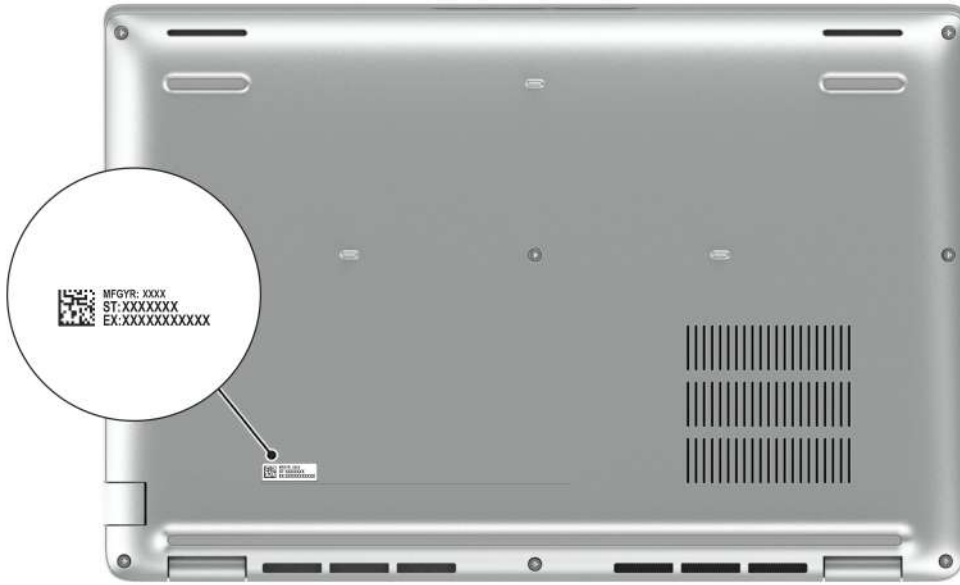

## Battery charge and status light

The following table lists the battery charge and status light behavior of your Precision 3480.

**Table 1. Battery charge and status light behavior**

Power Source	LED Behavior	System Power State	Battery Charge Level
AC Adapter	Off	S0 - S5	Fully Charged
AC Adapter	Solid White	S0 - S5	< Fully Charged
Battery	Off	S0 - S5	11-100%
Battery	Solid Amber (590+/-3 nm)	S0 - S5	< 10%

- S0 (ON) - System is turned on.
- S4 (Hibernate) - The system consumes the least power compared to all other sleep states. The system is almost at an OFF state, expect for a trickle power. The context data is written to hard drive.
- S5 (OFF) - The system is in a shutdown state.

# Set up your Precision 3480

## About this task

**NOTE:** The images in this document may differ from your computer depending on the configuration you ordered.

## Steps

1. Connect the power adapter and press the power button.



**NOTE:** The battery may go into power-saving mode during shipment to conserve charge on the battery. Ensure that the power adapter is connected to your computer when it is turned on for the first time.

2. Finish the operating system setup.

### For Ubuntu:

Follow the on-screen instructions to complete the setup. For more information about installing and configuring Ubuntu, search in the Knowledge Base Resource at [www.dell.com/support](http://www.dell.com/support).





### For Windows:

Follow the on-screen instructions to complete the setup. When setting up, Dell recommends that you:

- Connect to a network for Windows updates.
  - NOTE:** If connecting to a secured wireless network, enter the password for the wireless network access when prompted.
- If connected to the Internet, sign-in with or create a Microsoft account. If not connected to the Internet, create an offline account.
- On the **Support and Protection** screen, enter your contact details.

3. Locate and use Dell apps from the Windows Start menu—Recommended.

**Table 2. Locate Dell apps**

Resources	Description
	<p><b>Dell Product Registration</b></p> <p>Register your computer with Dell.</p>
	<p><b>Dell Help &amp; Support</b></p> <p>Access help and support for your computer.</p>
	<p><b>SupportAssist</b></p> <p>SupportAssist is the smart technology that keeps your computer running at its best by optimizing settings, detecting issues, removing viruses and notifies when you must make computer updates. SupportAssist proactively checks the health of your computer hardware and software. When an issue is detected, the necessary system state information is sent to Dell to begin troubleshooting. SupportAssist is preinstalled on most of the Dell devices running Windows operating system. For more information, see <i>SupportAssist for Business PCs manuals</i> at <a href="http://www.dell.com/support/home/product-support/product/supportassist-business-pcs/docs">www.dell.com/support/home/product-support/product/supportassist-business-pcs/docs</a>.</p> <p><b>NOTE:</b> In SupportAssist, click the warranty expiry date to renew or upgrade your warranty.</p>
	<p><b>Dell Update</b></p> <p>Updates your computer with critical fixes and latest device drivers as they become available. For more information about using Dell Update, see the product guides and third-party license documents at <a href="http://www.dell.com/support">www.dell.com/support</a>.</p>
	<p><b>Dell Digital Delivery</b></p> <p>Download software applications, which are purchased but not preinstalled on your computer. For more information about using Dell Digital Delivery, search in the Knowledge Base Resource at <a href="http://www.dell.com/support">www.dell.com/support</a>.</p>

# Specifications of Precision 3480

## Dimensions and weight

The following table lists the height, width, depth, and weight of your Precision 3480.

**Table 3. Dimensions and weight**

Description	Values
Height:	
Front height	19.06 mm (0.75 in.)
Rear height	21.04 mm (0.83 in.)
Width	321.35 mm (12.65 in.)
Depth	212 mm (8.35 in.)
Weight  <b>NOTE:</b> The weight of your computer depends on the configuration ordered and manufacturing variability.	1.39 kg (3.06 lb)

## Processor

The following table lists the details of the processors supported by your Precision 3480.

**Table 4. Processor**

Description	Option one	Option two	Option three	Option four	Option five	Option six
Processor type	13 <sup>th</sup> Generation Intel Core i5-1335U vPro Essentials	13 <sup>th</sup> Generation Intel Core i7-1355U vPro Essentials	13 <sup>th</sup> Generation Intel Core i5-1340P vPro Essentials	13 <sup>th</sup> Generation Intel Core i5-1350P vPro Enterprise	13 <sup>th</sup> Generation Intel Core i7-1360P vPro Essentials	13 <sup>th</sup> Generation Intel Core i7-1370P vPro Enterprise
Processor wattage	15 W	15 W	28 W	28 W	28 W	28 W
Processor total core count	10	10	12	12	12	14
Performance-cores	2	2	4	4	4	6
Efficient-cores	8	8	8	8	8	8
Processor total thread counts	12	12	16	16	16	20
<b>i</b> NOTE: Intel Hyper-Threading Technology is only available on Performance-cores.						
Processor speed	Up to 4.60 GHz	Up to 5 GHz	Up to 4.60 GHz	Up to 4.70 GHz	Up to 5 GHz	Up to 5.20 GHz
Performance-cores frequency						
Processor base frequency	1.30 GHz	1.70 GHz	1.90 GHz	1.90 GHz	2.20 GHz	1.90 GHz
Maximum turbo frequency	4.60 GHz	5 GHz	4.60 GHz	4.70 GHz	5 GHz	5.20 GHz
Efficient-cores frequency						
Processor base frequency	0.90 GHz	1.20 GHz	1.40 GHz	1.40 GHz	1.60 GHz	1.40 GHz
Maximum turbo frequency	3.40 GHz	3.70 GHz	3.40 GHz	3.50 GHz	3.70 GHz	3.90 GHz
Processor cache	12 MB	12 MB	12 MB	12 MB	18 MB	24 MB
Integrated graphics	Intel Iris Xe Graphics	Intel Iris Xe Graphics	Intel Iris Xe Graphics	Intel Iris Xe Graphics	Intel Iris Xe Graphics	Intel Iris Xe Graphics



# Chipset

The following table lists the details of the chipset supported by your Precision 3480.

**Table 5. Chipset**

Description	Values
Chipset	Integrated in the processor
Processor	13 <sup>th</sup> Generation Intel Core i5/i7
DRAM bus width	64-bit
Flash EPROM	Up to 64 MB
PCIe bus	Up to Gen 4

# Operating system

Your Precision 3480 supports the following operating systems:

- Windows 11 Home, 64-bit
- Windows 11 Pro, 64-bit
- Microsoft Windows 11 Pro downgrade (Win 10 Pro image FI + Win 11 Pro DPK)
- Windows 10 China G-SKU, 64-bit
- Ubuntu 22.04 LTS, 64-bit

# Memory

The following table lists the memory specifications of your Precision 3480.

**Table 6. Memory specifications**

Description	Values
Memory slots	Two-SODIMM slots
Memory type	<ul style="list-style-type: none"><li>• Dual-channel DDR4</li><li>• Dual-channel DDR5</li></ul>
Memory speed	<ul style="list-style-type: none"><li>• 3200 MT/s</li><li>• 4800 MT/s</li></ul>
Maximum memory configuration	64 GB
Minimum memory configuration	8 GB
Memory size per slot	8 GB, 16 GB, or 32 GB
Memory configurations supported	<ul style="list-style-type: none"><li>• 8 GB, 1 x 8 GB, DDR4, 3200 MT/s, single-channel</li><li>• 16 GB, 2 x 8 GB, DDR4, 3200 MT/s, dual-channel</li><li>• 16 GB, 1 x 16 GB, DDR4, 3200 MT/s, single-channel</li><li>• 32 GB, 2 x 16 GB, DDR4, 3200 MT/s, dual-channel</li><li>• 64 GB, 2 x 32 GB, DDR4, 3200 MT/s, dual-channel</li><li>• 8 GB, 1 x 8 GB, DDR5, 4800 MT/s, single-channel</li><li>• 16 GB, 2 x 8 GB, DDR5, 4800 MT/s, dual-channel</li></ul>

**Table 6. Memory specifications (continued)**

Description	Values
	<ul style="list-style-type: none"> <li>• 16 GB, 1 x 16 GB, DDR5, 4800 MT/s, single-channel</li> <li>• 32 GB, 2 x 16 GB, DDR5, 4800 MT/s, dual-channel</li> <li>• 64 GB, 2 x 32 GB, DDR5, 4800 MT/s, dual-channel</li> </ul>

## External ports

The following table lists the external ports of your Precision 3480.

**Table 7. External ports**

Description	Values
Network port	One RJ45 port
USB ports	<ul style="list-style-type: none"> <li>• Two Thunderbolt 4 port with DisplayPort Alt Mode/USB Type-C/USB4/Power Delivery</li> </ul> <p><b>NOTE:</b> You can connect a Dell Docking Station to this port. For more information, search in the Knowledge Base Resource at <a href="http://www.dell.com/support">www.dell.com/support</a>.</p> <ul style="list-style-type: none"> <li>• One USB 3.2 Gen 1 port with PowerShare</li> <li>• One USB 3.2 Gen 1 port</li> </ul>
Audio port	One Universal audio jack
Video port	One HDMI 2.0 port
Media-card reader	One smart card reader slot (optional)
Power-adaptor port	Supported through USB-C
Security-cable slot	One security-cable slot (wedge-shaped)
SIM-card slot	Nano-SIM card slot (optional)

## Internal slots

The following table lists the internal slots of your Precision 3480.

**Table 8. Internal slots**

Description	Values
M.2	<ul style="list-style-type: none"> <li>• One M.2 2230 slot for WiFi and Bluetooth combo card</li> <li>• One M.2 2230 slot for solid-state drive</li> <li>• One M.2 3042/3052 for WWAN slot (optional)</li> </ul> <p><b>NOTE:</b> To learn more about the features of different types of M.2 cards, search in the Knowledge Base Resource at <a href="http://www.dell.com/support">www.dell.com/support</a>.</p>

# Ethernet

The following table lists the wired Ethernet Local Area Network (LAN) specifications of your Precision 3480.

**Table 9. Ethernet specifications**

Description	Values
Model number	<ul style="list-style-type: none"> <li>Intel Jacksonville I219-LM 10/100/Gb (1000BASE-T) for vPRO configurations</li> <li>Intel Jacksonville I219-V 10/100/Gb (1000BASE-T) for non-vPRO configurations</li> </ul>
Transfer rate	10/100/1000 Mbps

# Wireless module

The following table lists the Wireless Local Area Network (WLAN) modules that are supported on your Precision 3480.

**Table 10. Wireless module specifications**

Description	Option one	Option two
Model number	Realtek RTL8852BE	Intel AX211
Transfer rate	Up to 1201 Mbps	Up to 2400 Mbps
Frequency bands supported	2.4 GHz/5 GHz	2.4 GHz/5 GHz/6 GHz
Wireless standards	<ul style="list-style-type: none"> <li>WiFi 802.11a/b/g</li> <li>Wi-Fi 4 (WiFi 802.11n)</li> <li>Wi-Fi 5 (WiFi 802.11ac)</li> <li>Wi-Fi 6 (WiFi 802.11ax)</li> </ul>	<ul style="list-style-type: none"> <li>WiFi 802.11a/b/g</li> <li>Wi-Fi 4 (WiFi 802.11n)</li> <li>Wi-Fi 5 (WiFi 802.11ac)</li> <li>Wi-Fi 6E (WiFi 802.11ax)</li> </ul> <p><b>NOTE:</b> Wi-Fi 6 is supported in regions where Wi-Fi 6E is unavailable.</p>
Encryption	<ul style="list-style-type: none"> <li>64-bit/128-bit WEP</li> <li>AES-CCMP</li> <li>TKIP</li> </ul>	<ul style="list-style-type: none"> <li>64-bit/128-bit WEP</li> <li>AES-CCMP</li> <li>TKIP</li> </ul>
Bluetooth wireless card	Bluetooth 5.3	Bluetooth 5.3
	<p><b>NOTE:</b> The version of the Bluetooth wireless card may vary depending on the operating system that is installed on your computer.</p>	

# WWAN module

The following table lists the Wireless Wide Area Network (WWAN) module supported on your Precision 3480.

**Table 11. WWAN module specifications**

Description	Option one	Option two
Model number	4G DW5823e, Intel XMM 7560R+ Global LTE-Advanced, CAT16	5G DW5931e, Intel 5G 5000 Global Gigabit NR/LTE, 3GPP Release 15
Form factor	M.2 3042 Key-B	M.2 3042 Key-B

**Table 11. WWAN module specifications (continued)**

Description	Option one	Option two
Host interface	PCIe Gen2	PCIe Gen3
Network standard	LTE FDD/TDD, WCDMA/HSPA+, GPS/GLONASS/BDS/Galileo	LTE FDD/TDD, WCDMA/HSPA+, GNSS/Beidou NR FR1(Sub6) FDD/TDD, LTE FDD/TDD, WCDMA/HSPA+, GPS/GLONASS/Galileo/BDS/QZSS
Transfer data rate	<ul style="list-style-type: none"> <li>● Up to 1 Gbps DL (Cat 16)</li> <li>● Up to 150 Mbps UL</li> </ul>	<ul style="list-style-type: none"> <li>● SA: DL 4.67 Gbps/UL 1.25Gbps</li> <li>● NSA: DL 3.74 Gbps/UL 700Mbps</li> <li>● LTE: DL 1.6 Gbps (CAT19)/UL 150 Mbps</li> <li>● UMTS: DL 384 Kbps / UL 384 Kbps</li> <li>● DL DC-HSPA+: 42 Mbps (CAT24)/UL 11.5 Mbps (CAT7)</li> </ul>
Operating frequency bands	<ul style="list-style-type: none"> <li>● LTE (B1, B2, B3, B4, B5, B7, B8, B12, B13, B14, B17, B18, B19, B20, B25, B26, B28, B29, B30, B32, B34, B38, B39, B40, B41(HPUE), B42, B43, B46(receiver only), B48, B66, B71)</li> <li>● WCDMA/HSPA+ (1, 2, 4, 5, 8)</li> </ul>	<ul style="list-style-type: none"> <li>● NR (n1, n2, n3, n5, n7, n8, n20, n25, n28, n30, n38, n40, n41, n48, n66, n71, n77, n78, n79)</li> <li>● LTE (B1, B2, B3, B4, B5, B7, B8, B12, B13, B14, B17, B18, B19, B20, B25, B26, B28, B29, B30, B32, B34, B38, B39, B40, B41, B42, B43, B46, B48, B66, B71)</li> <li>● WCDMA/HSPA+ (1, 2, 4, 5, 8)</li> </ul>
Power supply	DC 3.135 V to 4.4 V, Typical 3.3 V	DC 3.135 V to 4.4 V, Typical 3.3 V
SIM card	Supported through external SIM slot	Supported through external SIM slot
eSIM with dual SIM (DSSA)	Supported	Supported
Antenna diversity	Supported	Supported
Radio On/Off	Supported	Supported
Wake on wireless	Supported	Supported
Temperature	<ul style="list-style-type: none"> <li>● Normal operating temperature: -10°C to + 55°C</li> <li>● Extended Operating temperature: -20°C to +65°C</li> </ul>	<ul style="list-style-type: none"> <li>● Normal operating temperature: -10°C to + 55°C</li> <li>● Extended Operating temperature: -30°C to +75°C</li> <li>● Storage temperature: -40°C to +85°C</li> </ul>
Antenna connector	<ul style="list-style-type: none"> <li>● WWAN Main Antenna x 4</li> <li>● Supports 4x4 MIMO</li> </ul>	<ul style="list-style-type: none"> <li>● WWAN Main Antenna x 4</li> <li>● Supports 4x4 MIMO</li> </ul>

**i** **NOTE:** For instructions on how to find your computer's IMEI (International Mobile Station Equipment Identity) number, search in the Knowledge Base Resource at [www.dell.com/support](http://www.dell.com/support).

# Audio

The following table lists the audio specifications of your Precision 3480.

**Table 12. Audio specifications**

Description		Values
Audio controller		Realtek Waves, MaxxAudio 12.0
Stereo conversion		Supported
Internal audio interface		High definition audio interface
External audio interface		Universal Audio Jack
Number of speakers		2
Internal-speaker amplifier		Not supported
External volume controls		Keyboard shortcut controls
Speaker output:		
	Average speaker output	2 W
	Peak speaker output	2 W
Subwoofer output		Not supported
Microphone		Digital-array microphones in camera assembly

# Storage

This section lists the storage options on your Precision 3480.

**Table 13. Storage matrix**

Storage	Single M.2 socket	2nd M.2 socket
M.2 2230 solid-state drive	Yes	Not supported

**Table 14. Storage specifications**

Storage type	Interface type	Capacity
M.2 2230 solid-state drive	PCIe Gen4 x4 NVMe, up to 64 Gbps	Up to 2 TB

# Keyboard

The following table lists the keyboard specifications of your Precision 3480.

**Table 15. Keyboard specifications**

Description	Values
Keyboard type	Standard keyboard
Keyboard layout	QWERTY

**Table 15. Keyboard specifications (continued)**

Description	Values
Number of keys	<ul style="list-style-type: none"> <li>• English US, English International, Arabic, Canada bilingual (MUI), Chinese traditional, French-Canadian, Greek, Hebrew, Korean, Russian, Thai, Ukrainian: 79 keys</li> <li>• French-Canadian Quebec, Brazilian, Spanish, Belgian, Bulgarian, Czech &amp; Slovakian (MUI), Danish, English UK, Estonian, French European, German, Hungarian, Icelandic, Italian, Nordic (MUI), Norwegian, Portugese Iberian, Slovenian, Spanish (Castillian), Spanish (Latin America), Swedish/Finnish, Swiss European (MUI), Turkish, Turkish F: 80 keys</li> <li>• Japanese: 83 keys</li> </ul>
Keyboard size	X=19.05 mm key pitch Y=18.05 mm key pitch
Keyboard shortcuts	Some keys on your keyboard have two symbols on them. These keys can be used to type alternate characters or to perform secondary functions. To type the alternate character, press Shift and the desired key. To perform secondary functions, press fn and the desired key. For more information, see <a href="#">Keyboard function keys</a> .

## Keyboard function keys

The **F1-F12** keys at the top of the keyboard are function keys. By default, these keys are used to perform specific functions defined by the software application in use.

You can run the secondary tasks that are indicated by the symbols on the function keys by pressing the function key with **fn**, for example, **fn** and **F1**. See the table below for the list of secondary tasks and the key combinations to run them.

 **NOTE:** Keyboard characters may differ depending on the keyboard language configuration. Keys that are used for tasks remain the same, regardless of the keyboard language.

 **NOTE:** You can define the primary behavior of function keys in the **Function Key Behavior** menu of the BIOS setup program.

**Table 16. Secondary tasks of keyboard keys**

Key combination for task	What the task does
<b>fn</b> and <b>F1</b>	Operating system and application specific F1 behavior
<b>fn</b> and <b>F2</b>	Operating system and application specific F2 behavior
<b>fn</b> and <b>F3</b>	Operating system and application specific F3 behavior
<b>fn</b> and <b>F4</b>	Operating system and application specific F4 behavior
<b>fn</b> and <b>F5</b>	Operating system and application specific F5 behavior
<b>fn</b> and <b>F6</b>	Operating system and application specific F6 behavior
<b>fn</b> and <b>F8</b>	Operating system and application specific F8 behavior
<b>fn</b> and <b>F9</b>	Operating system and application specific F9 behavior
<b>fn</b> and <b>F10</b>	Operating system and application specific F10 behavior
<b>fn</b> and <b>F11</b>	Operating system and application specific F11 behavior
<b>fn</b> and <b>F12</b>	Operating system and application specific F12 behavior
<b>fn</b> and <b>Right Ctrl</b>	Open application menu

**Table 16. Secondary tasks of keyboard keys (continued)**

Key combination for task	What the task does
<b>fn</b> and <b>Cursor up</b>	Page up
<b>fn</b> and <b>Cursor down</b>	Page down

## Keys with alternate characters

There are other keys on your keyboard with alternate characters. The symbols that are shown at the bottom of these keys are the main characters that are displayed when the key is pressed; the symbols that are shown at the top of these keys are displayed when the key is pressed with the shift key. For example, if you press **2**, **2** is displayed; if you press **Shift** and **2**, **@** is displayed.

## Camera

The following table lists the camera specifications of your Precision 3480.

**Table 17. Camera specifications**

Description	Values
Number of cameras	One
Camera type	<ul style="list-style-type: none"><li>• FHD RGB camera</li><li>• FHD RGB+IR camera</li><li>• FHD RGB+IR camera with Ambient Light Sensor, Express Sign-In with Presence Detection and Intelligent Privacy</li></ul>
Camera location	Front camera
Camera sensor type	CMOS sensor technology
Camera resolution:	
Still image	2.07 megapixel
Video	1920 x 1080 (FHD) at 30 fps
Infrared camera resolution:	
Still image	0.23 megapixel
Video	640 x 360 at 30 fps
Diagonal viewing angle:	
Camera	80 degrees
Infrared camera	86.60 degrees

# Touchpad

The following table lists the touchpad specifications of your Precision 3480.

**Table 18. Touchpad specifications**

Description		Values
Touchpad resolution:		> 300 DPI
Touchpad dimensions:		
	Horizontal	115 mm
	Vertical	67 mm
Touchpad gestures		For more information about touchpad gestures available on: <ul style="list-style-type: none"> <li>Windows, see the Microsoft knowledge base article at <a href="https://support.microsoft.com">support.microsoft.com</a></li> <li>Ubuntu, see <a href="https://ubuntu.com/support">ubuntu.com/support</a></li> </ul>

# Power adapter

The following table lists the power adapter specifications of your Precision 3480.

**Table 19. Power adapter specifications**

Description	Option one	Option two	Option three
Type	Pecos 65 W, USB-C	100 W, USB-C	130 W, USB-C
Power-adapter dimensions:			
Height	28 mm (1.10 in.)	26.50 (1.04 in.)	22 mm (0.87 in.)
Width	51 mm (2.01 in.)	60 mm (2.36 in.)	66 mm (2.60 in.)
Depth	112 mm (4.41 in.)	122 mm (4.80 in.)	143 mm (5.63 in.)
Input voltage	100 VAC–240 VAC	100 VAC–240 VAC	100 VAC–240 VAC
Input frequency	50 Hz–60 Hz	50 Hz–60 Hz	50 Hz–60 Hz
Input current (maximum)	1.70 A	1.70 A	1.80 A
Output current (continuous)	<ul style="list-style-type: none"> <li>20 V/3.25 A (continuous)</li> <li>15 V/3 A (continuous)</li> <li>9 V/3 A (continuous)</li> <li>5 V/3 A (continuous)</li> </ul>	<ul style="list-style-type: none"> <li>20 V/5 A (continuous)</li> <li>15 V/3 A (continuous)</li> <li>9 V/3 A (continuous)</li> <li>5 V/3 A (continuous)</li> </ul>	<ul style="list-style-type: none"> <li>20 V/6.50 A (continuous)</li> <li>5 V/1 A (continuous)</li> </ul>
Rated output voltage	<ul style="list-style-type: none"> <li>20 VDC</li> <li>15 VDC</li> <li>9 VDC</li> <li>5 VDC</li> </ul>	<ul style="list-style-type: none"> <li>20 VDC</li> <li>15 VDC</li> <li>9 VDC</li> <li>5 VDC</li> </ul>	<ul style="list-style-type: none"> <li>20 VDC</li> <li>5 VDC</li> </ul>
Temperature range:			
Operating	0°C to 40°C (32°F to 104°F)	0°C to 40°C (32°F to 104°F)	0°C to 40°C (32°F to 104°F)



**Table 19. Power adapter specifications (continued)**

Description	Option one	Option two	Option three
Storage	-40°C to 70°C (-40°F to 158°F)	-40°C to 70°C (-40°F to 158°F)	-40°C to 70°C (-40°F to 158°F)
 <b>CAUTION:</b> Operating and storage temperature ranges may differ among components, so operating or storing the device outside these ranges may impact the performance of specific components.			

## Battery

The following table lists the battery specifications of your Precision 3480.

**Table 20. Battery specifications**

Description	Option one	Option two	Option three	Option four
Battery type	3 cell, 42 Wh, ExpressCharge, ExpressCharge Boost	3 cell, 42 Wh, Long Cycle Life, ExpressCharge	3 cell, 54 Wh, ExpressCharge, ExpressCharge Boost	3 cell, 54 Wh, Long Cycle Life, ExpressCharge
Battery voltage	11.40 VDC	11.40 VDC	11.40 VDC	11.40 VDC
Battery weight (minimum)	0.19 kg (0.41 lb)	0.19 kg (0.41 lb)	0.22 kg (0.48 lb)	0.22 kg (0.48 lb)
Battery dimensions:				
	Height	5.73 mm (0.22 in.)	5.73 mm (0.22 in.)	5.73 mm (0.22 in.)
	Width	263 mm (10.35 in.)	263 mm (10.35 in.)	263 mm (10.35 in.)
	Depth	68.90 mm (2.71 in.)	68.90 mm (2.71 in.)	68.90 mm (2.71 in.)
Temperature range:				
	Operating	<ul style="list-style-type: none"> <li>Charge: 0°C to 45°C (32°F to 113°F)</li> <li>Discharge: 0°C to 70°C (32°F to 158°F)</li> </ul>	<ul style="list-style-type: none"> <li>Charge: 0°C to 45°C (32°F to 113°F)</li> <li>Discharge: 0°C to 70°C (32°F to 158°F)</li> </ul>	<ul style="list-style-type: none"> <li>Charge: 0°C to 45°C (32°F to 113°F)</li> <li>Discharge: 0°C to 70°C (32°F to 158°F)</li> </ul>
	Storage	-20°C to 65°C (-4°F to 149°F)	-20°C to 65°C (-4°F to 149°F)	-20°C to 65°C (-4°F to 149°F)
Battery operating time	Varies depending on operating conditions and can significantly reduce under certain power-intensive conditions.	Varies depending on operating conditions and can significantly reduce under certain power-intensive conditions.	Varies depending on operating conditions and can significantly reduce under certain power-intensive conditions.	Varies depending on operating conditions and can significantly reduce under certain power-intensive conditions.
Battery charging time (approximate)	<b>Express Charge Method:</b> <ul style="list-style-type: none"> <li>0°C - 15°C maximum allowable charge time from 0% to 100% RSOC is 4 hours</li> </ul>	<b>Express Charge Method:</b> <ul style="list-style-type: none"> <li>0°C to 15°C maximum allowable charge time from 0% to 100% RSOC is 4 hours</li> </ul>	<b>Express Charge Method:</b> <ul style="list-style-type: none"> <li>0°C - 15°C maximum allowable charge time from 0% to 100% RSOC is 4 hours</li> </ul>	<b>Express Charge Method:</b> <ul style="list-style-type: none"> <li>0°C to 15°C maximum allowable charge time from 0% to 100% RSOC is 4 hours</li> </ul>

**Table 20. Battery specifications (continued)**

Description	Option one	Option two	Option three	Option four
<p>search in the Knowledge Base Resource at <a href="http://www.dell.com/support">www.dell.com/support</a>.</p>	<ul style="list-style-type: none"> <li>16°C - 45°C normal express charge</li> <li>46°C - 50°C maximum allowable charge time from 0% to 100% RSOC is 3 hours</li> </ul> <p><b>Standard Charge/ Predominately AC User Charge Method:</b></p> <ul style="list-style-type: none"> <li>0°C - 15°C maximum allowable charge time from 0% to 100% RSOC is 4 hours</li> <li>16°C - 50°C maximum allowable charge time from 0% to 100% RSOC is 3 hours</li> </ul> <p><b>Express Charge Boost Charge Method (Fast Charge for Initial 35%):</b></p> <ul style="list-style-type: none"> <li>16°C - 45°C target charge time from 0% to 35% RSOC is 20 mins for Accelerated Charge</li> </ul>	<ul style="list-style-type: none"> <li>16°C to 45°C normal express charge</li> <li>46°C to 50°C maximum allowable charge time from 0% to 100% RSOC is 3 hours</li> </ul> <p><b>Standard Charge/ Predominately AC User Charge Method:</b></p> <ul style="list-style-type: none"> <li>0°C - 15°C maximum allowable charge time from 0% to 100% RSOC is 4 hours</li> <li>16°C - 50°C maximum allowable charge time from 0% to 100% RSOC is 3 hours</li> </ul>	<ul style="list-style-type: none"> <li>16°C - 45°C normal express charge</li> <li>46°C - 50°C maximum allowable charge time from 0% to 100% RSOC is 3 hours</li> </ul> <p><b>Standard Charge/ Predominately AC User Charge Method:</b></p> <ul style="list-style-type: none"> <li>0°C - 15°C maximum allowable charge time from 0% to 100% RSOC is 4 hours</li> <li>16°C - 50°C maximum allowable charge time from 0% to 100% RSOC is 3 hours</li> </ul> <p><b>Express Charge Boost Charge Method (Fast Charge for Initial 35%):</b></p> <ul style="list-style-type: none"> <li>16°C - 45°C target charge time from 0% to 35% RSOC is 20 mins for Accelerated Charge</li> </ul>	<ul style="list-style-type: none"> <li>16°C to 45°C normal express charge</li> <li>46°C to 50°C maximum allowable charge time from 0% to 100% RSOC is 3 hours</li> </ul> <p><b>Standard Charge/ Predominately AC User Charge Method:</b></p> <ul style="list-style-type: none"> <li>0°C - 15°C maximum allowable charge time from 0% to 100% RSOC is 4 hours</li> <li>16°C - 50°C maximum allowable charge time from 0% to 100% RSOC is 3 hours</li> </ul>
Coin-cell battery	CR2032	CR2032	CR2032	CR2032
<p><b>CAUTION:</b> Operating and storage temperature ranges may differ among components, so operating or storing the device outside these ranges may impact the performance of specific components.</p> <p><b>CAUTION:</b> Dell recommends that you charge the battery regularly for optimal power consumption. If your battery charge is completely depleted, connect the power adapter, turn on your computer, and then restart your computer to reduce the power consumption.</p>				

## Display

The following table lists the display specifications of your Precision 3480.

**Table 21. Display specifications**

Description	Option one	Option two	Option three
Display type	14-inch Full High Definition (FHD)	14-inch Full High Definition (FHD)	14-inch Full High Definition (FHD), ComfortView Plus Low Blue Light, battery saving

**Table 21. Display specifications (continued)**

Description		Option one	Option two	Option three
Touch options		No	Yes	No
Display-panel technology		In-Plane Switching (IPS)	In-Plane Switching (IPS)	In-Plane Switching (IPS)
Display-panel dimensions (active area):				
	Height	173.95 mm (6.84 in.)	173.95 mm (6.84 in.)	173.95 mm (6.84 in.)
	Width	309.40 mm (12.18 in.)	309.40 mm (12.18 in.)	309.40 mm (12.18 in.)
	Diagonal	355.60 mm (14 in.)	355.60 mm (14 in.)	355.60 mm (14 in.)
Display-panel native resolution		1920 x 1080	1920 x 1080	1920 x 1080
Luminance (typical)		250 nits	300 nits	400 nits
Megapixels		2.07	2.07	2.07
Color gamut		45% NTSC (typical)	72% NTSC (typical)	100% sRGB (typical)
Pixels Per Inch (PPI)		157	157	157
Contrast ratio (typical)		600:1	600:1	1000:1
Response time (max)		35 ms	35 ms	35 ms
Refresh rate		60 Hz	60 Hz	60 Hz
Horizontal view angle		+/- 85 degrees	+/- 85 degrees	+/- 85 degrees
Vertical view angle		+/- 85 degrees	+/- 85 degrees	+/- 85 degrees
Pixel pitch		0.161 x 0.161 mm	0.161 x 0.161 mm	0.161 x 0.161 mm
Power consumption (maximum)		3.10 W	4.60 W	2.50 W
Anti-glare vs glossy finish		Anti-glare	Anti-glare	Anti-glare

## Fingerprint reader (optional)

The following table lists the specifications of the optional fingerprint-reader of your Precision 3480.

**Table 22. Fingerprint reader specifications**

Description	Values
Fingerprint-reader sensor technology	Capacitive
Fingerprint-reader sensor resolution	500 dpi
Fingerprint-reader sensor pixel size	108 x 88

## Sensor

The following table lists the sensor of your Precision 3480.

**Table 23. Sensor**

Sensor support
Ambient Light Sensor
Accelerometer in the base: ST Micro LIS2DW12TR
Accelerometer in the hinge-up (Upsell config with Emza/ALS/IR camera): ST Micro LNG2DMTR

## GPU—Integrated

The following table lists the specifications of the integrated Graphics Processing Unit (GPU) supported by your Precision 3480.

**Table 24. GPU—Integrated**

Controller	Memory size	Processor
Intel Iris Xe Graphics	Dual-channel memory	13 <sup>th</sup> Generation Intel Core i5/i7

## GPU—Discrete

The following table lists the specifications of the discrete Graphics Processing Unit (GPU) supported by your Precision 3480.

**Table 25. GPU—Discrete**

Controller	Memory size	Memory type
NVIDIA RTX A500	4 GB	GDDR6

## External display support

The following table lists the external display support for your Precision 3480.

**Table 26. External display support**

Graphics card	Supported external displays with laptop display enabled	Supported external displays with laptop display disabled
Intel Iris Xe Graphics	3	4

## Hardware security

The following table lists the hardware security of your Precision 3480.

**Table 27. Hardware security**

Hardware security
Trusted Platform Module (TPM) 2.0 discrete
FIPS 140-2 certification for TPM
TCG Certification for TPM (Trusted Computing Group)

**Table 27. Hardware security (continued)**

<b>Hardware security</b>
Finger Print Reader in Power Button tied to ControlVault 3 (optional)
ControlVault 3 Advanced Authentication with FIPS 140-2 Level 3 Certification
Contacted Smart Card and ControlVault 3
Contactless Smart Card, NFC, and ControlVault 3
SED SSD NVMe, SSD and HDD (Opal and non-Opal) per SDL

## Smart-card reader

### Contactless smart-card reader

This section lists the contactless smart-card reader specifications of your Precision 3480.

**Table 28. Contactless smart-card reader specifications**

<b>Title</b>	<b>Description</b>	<b>Dell ControlVault 3 contactless smart-card reader with NFC</b>
Felica Card Support	Reader and software capable of supporting Felica contactless cards	Yes
ISO 14443 Type A Card Support	Reader and software capable of supporting ISO 14443 Type A contactless cards	Yes
ISO 14443 Type B Card Support	Reader and software capable of supporting ISO 14443 Type B contactless cards	Yes
ISO/IEC 21481	Reader and software capable of supporting ISO/IEC 21481 compliant contactless cards and tokens	Yes
ISO/IEC 18092	Reader and software capable of supporting ISO/IEC 21481 compliant contactless cards and tokens	Yes
ISO 15693 Card Support	Reader and software capable of supporting ISO15693 contactless cards	Yes
NFC Tag Support	Supports reading and processing of NFC compliant tag information	Yes
NFC Reader Mode	Support for NFC Forum Defined Reader mode	Yes
NFC Writer Mode	Support for NFC Forum Defined Writer mode	Yes
NFC Peer-to-Peer Mode	Support for NFC Forum Defined Peer to Peer mode	Yes
EMVCo Compliant	Compliant with EMVCO smart card standards as posted to <a href="http://www.emvco.com">www.emvco.com</a>	Yes
EMVCo Certified	Formally certified based on EMVCO smart card standards	Yes
NFC Proximity OS Interface	Enumerates NFP (Near Field Proximity) device for OS to utilize	Yes

**Table 28. Contactless smart-card reader specifications (continued)**

Title	Description	Dell ControlVault 3 contactless smart-card reader with NFC
PC/SC OS interface	Personal Computer/Smart Card specification for integration of hardware readers into personal computer environments	Yes
CCID driver compliance	Common driver support for Integrated Circuit Card Interface Device for OS level drivers	Yes
Windows Certified	Device certified by Microsoft WHCK	Yes
Dell ControlVault support	Device connects to Dell ControlVault for usage and processing	Yes
FIDO2 compliance	Dell ControlVault 3 Smart-card reader is compliant with the FIDO SPEC	Yes

**i** | **NOTE:** 125 Khz proximity cards are not supported.

**Table 29. Supported cards**

Manufacturer	Card
HID	jCOP readertest3 A card (14443a)
	1430 1L
	DESFire D8H
	iClass (Legacy)
	iClass SEOS
NXP/Mifare	Mifare DESFire 8K White PVC Cards
	Mifare Classic 1K White PVC Cards
	NXP Mifare Classic S50 ISO Card
G&D	idOnDemand - SCE3.2 144K
	SCE6.0 FIPS 80K Dual+ 1 K Mifare
	SCE6.0 nonFIPS 80K Dual+ 1 K Mifare
	SCE6.0 FIPS 144K Dual + 1K Mifare
	SCE6.0 nonFIPS 144K Dual + 1 K Mifare
	SCE7.0 FIPS 144K
Oberthur	idOnDemand - OCS5.2 80K
	ID-One Cosmo 64 RSA D V5.4 T=0 card

## Contacted smart-card reader

The following table lists the contacted smart-card reader specifications of your Precision 3480.

**Table 30. Contacted smart-card reader specifications**

Title	Description	Dell ControlVault 3 smart-card reader
ISO 7816 -3 Class A Card Support	Reader capable of reading 5 V powered smart mcard	Yes

**Table 30. Contacted smart-card reader specifications (continued)**

Title	Description	Dell ControlVault 3 smart-card reader
ISO 7816 -3 Class B Card Support	Reader capable of reading 3 V powered smart card	Yes
ISO 7816 -3 Class C Card support	Reader capable of reading 1.8 V powered smart card	Yes
ISO 7816-1 Compliant	Specification for the reader	Yes
ISO 7816 -2 Compliant	Specification for smart card device physical characteristics (size, location of connection points, etc.)	Yes
T=0 support	Cards support character level transmission	Yes
T=1 support	Cards support block level transmission	Yes
EMVCo Compliant	Compliant with EMVCo (for electronic payment standards) smart card standards as posted to <a href="http://www.emvco.com">www.emvco.com</a>	Yes
EMVCo Certified	Formally certified based on EMVCO smart card standards	Yes
PC/SC OS interface	Personal Computer/Smart Card specification for integration of hardware readers into personal computer environments	Yes
CCID driver compliance	Common driver support for Integrated Circuit Card Interface Device for OS level drivers.	Yes
Windows Certified	Device certified by WHCK	Yes
FIPS 201 (PIV/HSPD-12) Compliant via GSA	Device compliant with FIPS 201/PIV/HSPD-12 requirements	Yes
FIDO2 compliance	Dell ControlVault 3 Smart-card reader is compliant with the FIDO SPEC	Yes

## Operating and storage environment

This table lists the operating and storage specifications of your Precision 3480.

**Airborne contaminant level:** G1 as defined by ISA-S71.04-1985

**Table 31. Computer environment**

Description	Operating	Storage
Temperature range	0°C to 35°C (32°F to 95°F)	-40°C to 65°C (-40°F to 149°F)
Relative humidity (maximum)	10% to 90% (non-condensing)	0% to 95% (non-condensing)
Vibration (maximum)*	0.66 GRMS	1.30 GRMS
Shock (maximum)	110 G†	160 G†
Altitude range	-15.20 m to 3048 m (-49.87 ft to 10000 ft)	-15.20 m to 10668 m (-49.87 ft to 35000 ft)

**Table 31. Computer environment (continued)**

Description	Operating	Storage
 <b>CAUTION: Operating and storage temperature ranges may differ among components, so operating or storing the device outside these ranges may impact the performance of specific components.</b>		

\* Measured using a random vibration spectrum that simulates user environment.

† Measured using a 2 ms half-sine pulse.

## Dell Support policy

For information on Dell support policy, search in the Knowledge Base Resource at [www.dell.com/support](http://www.dell.com/support).

## ComfortView Plus

 **WARNING: Prolonged exposure to blue light from the display may lead to long-term effects such as eye strain, eye fatigue, or damage to the eyes.**

Blue light is a color in the light spectrum which has a short wavelength and high energy. Chronic exposure to blue light, particularly from digital sources, may disrupt sleep patterns and cause long-term effects such as eye strain, eye fatigue, or damage to the eyes.

The display on this computer is designed to minimize blue light and complies with TÜV Rheinland's requirement for low blue light displays.

Low blue light mode is enabled at the factory, so no further configuration is necessary.

To reduce the risk of eye strain, it is also recommended that you:

- Position the display at a comfortable viewing distance between 20 and 28 inches (50 and 70 cm) from your eyes.
- Blink frequently to moisten your eyes, wet your eyes with water, or apply suitable eye drops.
- Look away from your display, and gaze at a distant object at 20 ft (609.60 cm) away for at least 20 seconds during each break.
- Take an extended break for 20 minutes every two hours.

## Using the privacy shutter

1. Slide the privacy shutter to the left to access the camera lens.
2. Slide the privacy shutter to the right to cover the camera lens.





Figure 1. Camera shutter

## Dell Optimizer

This section provides the Dell Optimizer specifications of your Precision 3480.

On Precision 3480 with Dell Optimizer, the following features are supported:











- **ExpressConnect**—Automatically joins the access point with the strongest signal, and directs bandwidth to conferencing applications when in use.
- **ExpressSign-in**—The Intel Context Sensing Technology's proximity sensor detects your presence to instantly wake up the computer and login using the IR camera and Windows Hello feature. Windows locks when you walk away.
- **ExpressResponse**—Prioritizes the most important applications. Applications open faster and perform better.
- **ExpressCharge**—Extends the battery runtime and improves battery performance by adapting to your patterns.
- **Intelligent Audio**—Collaborate like you're in the same room. Intelligent Audio enhances your audio quality and reduces background noises, so you can hear and be heard, creating a better conference experience for all.

For more information about configuring and using these features, see [Dell Optimizer User Guide](#).

# Working inside your computer



## Safety instructions

Use the following safety guidelines to protect your computer from potential damage and to ensure your personal safety. Unless otherwise noted, each procedure included in this document assumes that you have read the safety information that shipped with your computer.

-  **WARNING:** Before working inside your computer, read the safety information that is shipped with your computer. For more safety best practices, see the Regulatory Compliance home page at [www.dell.com/regulatory\\_compliance](http://www.dell.com/regulatory_compliance).
-  **WARNING:** Disconnect your computer from all power sources before opening the computer cover or panels. After you finish working inside the computer, replace all covers, panels, and screws before connecting your computer to an electrical outlet.
-  **CAUTION:** To avoid damaging the computer, ensure that the work surface is flat, dry, and clean.
-  **CAUTION:** To avoid damaging the components and cards, handle them by their edges, and avoid touching the pins and the contacts.
-  **CAUTION:** You should only perform troubleshooting and repairs as authorized or directed by the Dell technical assistance team. Damage due to servicing that is not authorized by Dell is not covered by your warranty. See the safety instructions that is shipped with the product or at [www.dell.com/regulatory\\_compliance](http://www.dell.com/regulatory_compliance).
-  **CAUTION:** Before touching anything inside your computer, ground yourself by touching an unpainted metal surface, such as the metal at the back of the computer. While you work, periodically touch an unpainted metal surface to dissipate static electricity which could harm internal components.
-  **CAUTION:** When you disconnect a cable, pull it by its connector or its pull tab, not the cable itself. Some cables have connectors with locking tabs or thumbscrews that you must disengage before disconnecting the cable. When disconnecting cables, keep them evenly aligned to avoid bending the connector pins. When connecting cables, ensure that the ports and the connectors are correctly oriented and aligned.
-  **CAUTION:** Press and eject any installed card from the media-card reader.
-  **CAUTION:** Exercise caution when handling Lithium-ion batteries in laptops. Swollen batteries should not be used and should be replaced and disposed properly.
-  **NOTE:** The color of your computer and certain components may appear differently than shown in this document.

## Before working inside your computer

### Steps

1. Save and close all open files and exit all open applications.
2. Shut down your computer. For Windows operating system, click **Start** >  **Power** > **Shut down**.
  -  **NOTE:** If you are using a different operating system, see the documentation of your operating system for shut-down instructions.
3. Disconnect your computer and all attached devices from their electrical outlets.
4. Disconnect all attached network devices and peripherals, such as keyboard, mouse, and monitor from your computer.

5. Remove any media card and optical disk from your computer, if applicable.
6. Enter the service mode, if you are able to power on your computer.

### Service Mode

Service Mode is used to cut-off power, without disconnecting battery cable from system board prior conducting repairs in the computer.

 **CAUTION:** If you are unable to turn on the computer to put it into Service Mode, or the computer does not support Service Mode, proceed to disconnect the battery cable. To disconnect the battery cable, follow the steps in [Removing the battery](#).

 **NOTE:** Ensure that your computer is shut down and the AC adapter is disconnected.

- a. Hold **<B>** key on the keyboard and press the power button for 3 seconds or until the Dell logo appears on the screen.
- b. Press any key to continue.
- c. If the AC adapter is not disconnected, a message prompting you to remove the AC adapter appears on the screen. Remove the AC adapter and then press any key to continue the **Service Mode** process. The **Service Mode** process automatically skips the following step if the **Owner Tag** of the computer is not set up in advance by the user.
- d. When the **ready-to-proceed** message appears on the screen, press any key to proceed. The computer emits three short beeps and shuts down immediately.
- e. Once the computer shuts down, it has successfully entered Service Mode.

 **NOTE:** If you are unable to power on your computer or unable to enter Service Mode, skip this process.

## Safety precautions

The safety precautions chapter details the primary steps to be taken before performing any disassembly instructions.

Observe the following safety precautions before you perform any installation or break/fix procedures involving disassembly or reassembly:

- Turn off the system and all attached peripherals.
- Disconnect the system and all attached peripherals from AC power.
- Disconnect all network cables, telephone, and telecommunications lines from the system.
- Use an ESD field service kit when working inside any notebook to avoid electrostatic discharge (ESD) damage.
- After removing any system component, carefully place the removed component on an anti-static mat.
- Wear shoes with non-conductive rubber soles to reduce the chance of getting electrocuted.

## Standby power

Dell products with standby power must be unplugged before you open the case. Systems that incorporate standby power are essentially powered while turned off. The internal power enables the system to be remotely turned on (wake on LAN) and suspended into a sleep mode and has other advanced power management features.

Unplugging, pressing, and holding the power button for 15 seconds should discharge residual power in the system board.

## Bonding

Bonding is a method for connecting two or more grounding conductors to the same electrical potential. This is done through the use of a field service electrostatic discharge (ESD) kit. When connecting a bonding wire, ensure that it is connected to bare metal and never to a painted or non-metal surface. The wrist strap should be secure and in full contact with your skin, and ensure that you remove all jewelry such as watches, bracelets, or rings prior to bonding yourself and the equipment.

## Electrostatic discharge—ESD protection

ESD is a major concern when you handle electronic components, especially sensitive components such as expansion cards, processors, memory DIMMs, and system boards. Very slight charges can damage circuits in ways that may not be obvious, such as intermittent problems or a shortened product life span. As the industry pushes for lower power requirements and increased density, ESD protection is an increasing concern.

Due to the increased density of semiconductors used in recent Dell products, the sensitivity to static damage is now higher than in previous Dell products. For this reason, some previously approved methods of handling parts are no longer applicable.

Two recognized types of ESD damage are catastrophic and intermittent failures.

- **Catastrophic** – Catastrophic failures represent approximately 20 percent of ESD-related failures. The damage causes an immediate and complete loss of device functionality. An example of catastrophic failure is a memory DIMM that has received a static shock and immediately generates a "No POST/No Video" symptom with a beep code emitted for missing or nonfunctional memory.
- **Intermittent** – Intermittent failures represent approximately 80 percent of ESD-related failures. The high rate of intermittent failures means that most of the time when damage occurs, it is not immediately recognizable. The DIMM receives a static shock, but the tracing is merely weakened and does not immediately produce outward symptoms related to the damage. The weakened trace may take weeks or months to melt, and in the meantime may cause degradation of memory integrity, intermittent memory errors, etc.

The more difficult type of damage to recognize and troubleshoot is the intermittent (also called latent or "walking wounded") failure.

Perform the following steps to prevent ESD damage:

- Use a wired ESD wrist strap that is properly grounded. The use of wireless anti-static straps is no longer allowed; they do not provide adequate protection. Touching the chassis before handling parts does not ensure adequate ESD protection on parts with increased sensitivity to ESD damage.
- Handle all static-sensitive components in a static-safe area. If possible, use anti-static floor pads and workbench pads.
- When unpacking a static-sensitive component from its shipping carton, do not remove the component from the anti-static packing material until you are ready to install the component. Before unwrapping the anti-static packaging, ensure that you discharge static electricity from your body.
- Before transporting a static-sensitive component, place it in an anti-static container or packaging.

## ESD field service kit

The unmonitored Field Service kit is the most commonly used service kit. Each Field Service kit includes three main components: anti-static mat, wrist strap, and bonding wire.

### Components of an ESD field service kit

The components of an ESD field service kit are:

- **Anti-Static Mat** – The anti-static mat is dissipative and parts can be placed on it during service procedures. When using an anti-static mat, your wrist strap should be snug and the bonding wire should be connected to the mat and to any bare metal on the system being worked on. Once deployed properly, service parts can be removed from the ESD bag and placed directly on the mat. ESD-sensitive items are safe in your hand, on the ESD mat, in the system, or inside a bag.
- **Wrist Strap and Bonding Wire** – The wrist strap and bonding wire can be either directly connected between your wrist and bare metal on the hardware if the ESD mat is not required, or connected to the anti-static mat to protect hardware that is temporarily placed on the mat. The physical connection of the wrist strap and bonding wire between your skin, the ESD mat, and the hardware is known as bonding. Use only Field Service kits with a wrist strap, mat, and bonding wire. Never use wireless wrist straps. Always be aware that the internal wires of a wrist strap are prone to damage from normal wear and tear, and must be checked regularly with a wrist strap tester in order to avoid accidental ESD hardware damage. It is recommended to test the wrist strap and bonding wire at least once per week.
- **ESD Wrist Strap Tester** – The wires inside of an ESD strap are prone to damage over time. When using an unmonitored kit, it is a best practice to regularly test the strap prior to each service call, and at a minimum, test once per week. A wrist strap tester is the best method for doing this test. If you do not have your own wrist strap tester, check with your regional office to find out if they have one. To perform the test, plug the wrist-strap's bonding-wire into the tester while it is strapped to your wrist and push the button to test. A green LED is lit if the test is successful; a red LED is lit and an alarm sounds if the test fails.
- **Insulator Elements** – It is critical to keep ESD sensitive devices, such as plastic heat sink casings, away from internal parts that are insulators and often highly charged.
- **Working Environment** – Before deploying the ESD Field Service kit, assess the situation at the customer location. For example, deploying the kit for a server environment is different than for a desktop or portable environment. Servers are typically installed in a rack within a data center; desktops or portables are typically placed on office desks or cubicles. Always look for a large open flat work area that is free of clutter and large enough to deploy the ESD kit with additional space to accommodate the type of system that is being repaired. The workspace should also be free of insulators that can cause an ESD event. On the work area, insulators such as Styrofoam and other plastics should always be moved at least 12 inches or 30 centimeters away from sensitive parts before physically handling any hardware components

- **ESD Packaging** – All ESD-sensitive devices must be shipped and received in static-safe packaging. Metal, static-shielded bags are preferred. However, you should always return the damaged part using the same ESD bag and packaging that the new part arrived in. The ESD bag should be folded over and taped shut and all the same foam packing material should be used in the original box that the new part arrived in. ESD-sensitive devices should be removed from packaging only at an ESD-protected work surface, and parts should never be placed on top of the ESD bag because only the inside of the bag is shielded. Always place parts in your hand, on the ESD mat, in the system, or inside an anti-static bag.
- **Transporting Sensitive Components** – When transporting ESD sensitive components such as replacement parts or parts to be returned to Dell, it is critical to place these parts in anti-static bags for safe transport.

## ESD protection summary

It is recommended to use the traditional wired ESD grounding wrist strap and protective anti-static mat at all times when servicing Dell products. In addition, it is critical to keep sensitive parts separate from all insulator parts while performing service and that they use anti-static bags for transporting sensitive components.

## Transporting sensitive components

When transporting ESD sensitive components such as replacement parts or parts to be returned to Dell, it is critical to place these parts in anti-static bags for safe transport.

## After working inside your computer

### About this task

 **CAUTION:** Leaving stray or loose screws inside your computer may severely damage your computer.

### Steps

1. Replace all screws and ensure that no stray screws remain inside your computer.
2. Connect any external devices, peripherals, or cables you removed before working on your computer.
3. Replace any media cards, discs, or any other parts that you removed before working on your computer.
4. Connect your computer and all attached devices to their electrical outlets.
  -  **NOTE:** To exit service mode, ensure to connect the AC adapter to the power-adapter port on your computer.
5. Press the power button to turn on the computer. Your computer will automatically return to normal functioning mode.

## BitLocker

 **CAUTION:** If BitLocker is not suspended before updating the BIOS, the next time you reboot the system it will not recognize the BitLocker key. You will then be prompted to enter the recovery key to progress, and the system will ask for this on each reboot. If the recovery key is not known this can result in data loss or an unnecessary operating system reinstall. For more information about this subject, see [Knowledge Article: updating the BIOS on Dell systems with BitLocker enabled](#).

The installation of the following components triggers BitLocker:

- Hard disk drive or solid state drive
- System board

## Recommended tools















The procedures in this document may require the following tools:

- Phillips screwdriver #0
- Phillips screwdriver #1
- Plastic scribe

# Screw list

- NOTE:** When removing screws from a component, it is recommended to note the screw type, the quantity of screws, and then place them in a screw storage box. This is to ensure that the correct number of screws and correct screw type is restored when the component is replaced.
- NOTE:** Some computers have magnetic surfaces. Ensure that the screws are not left attached to such surfaces when replacing a component.
- NOTE:** Screw color may vary with the configuration ordered.

**Table 32. Screw list**

Component	Screw type	Quantity	Screw image
M.2 2230 solid-state drive thermal shield	M2x3	2	
WWAN card	M2x3	2	
Fan	M2x5	2	
Assembly inner frame	M2x3	8	
Smart card reader	M2x2.5	3	
Power-button board	M2x2.5	2	
Keyboard bracket	M2x2	17	
Keyboard	M2x2	4	
Fingerprint reader bracket	M2x3	1	
Display cable bracket	M2x3	2	
System board	M2x4	3	
USB Type-C bracket	M2x5	3	
Left and right display hinges (secured to palm-rest assembly)	M2.5x5	4	
Display panel	M2.5x3	2	
Display hinges (secured to display back cover)	M2.5x3	4	

# Major components of Precision 3480

The following image shows the major components of Precision 3480.

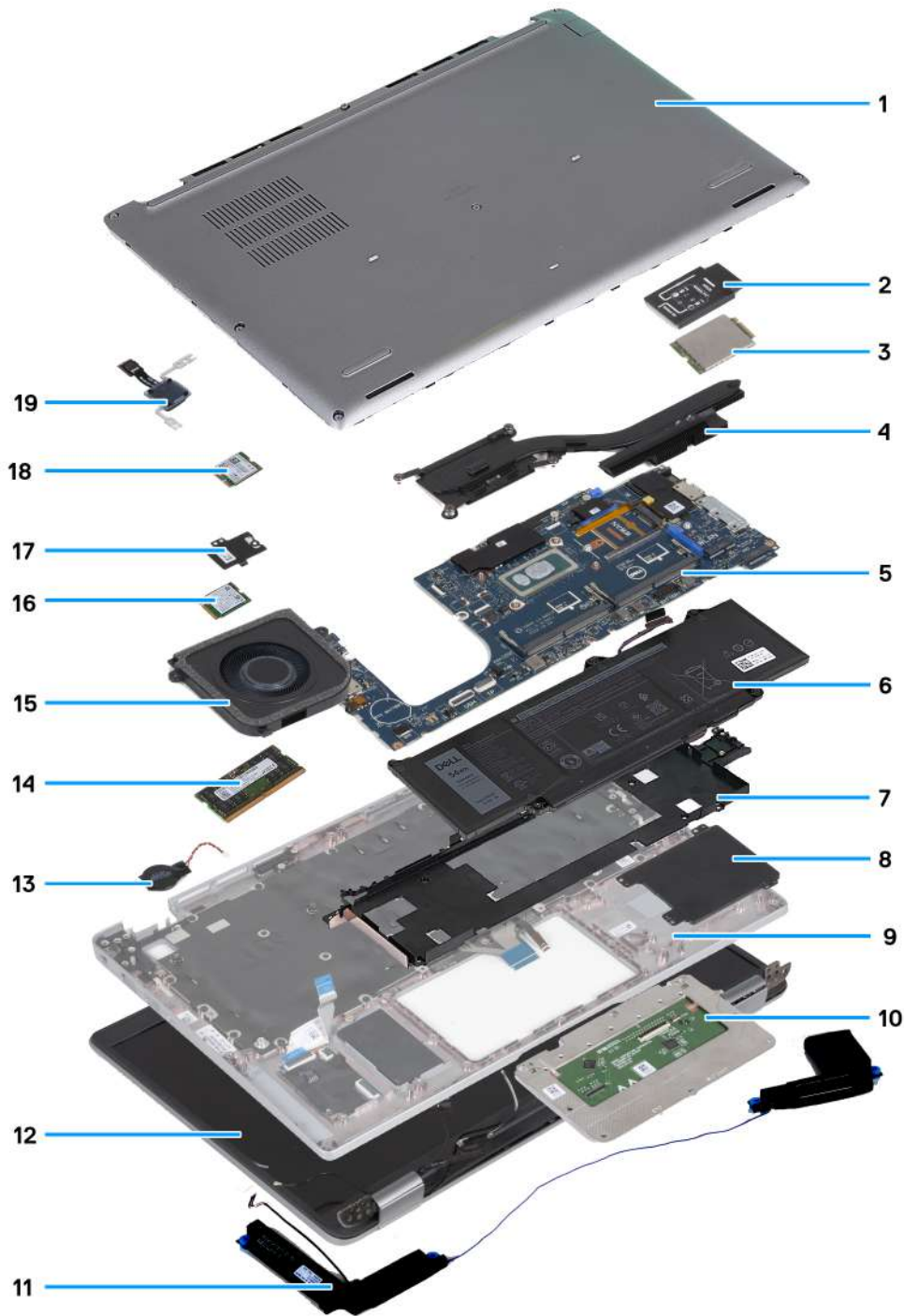

- 1. Base cover
- 3. WWAN card
- 5. System board
- 7. Assembly inner frame
- 9. Palm-rest assembly
- 11. Speakers
- 13. Coin-cell battery
- 15. Fan

- 2. WWAN card bracket
- 4. Heat sink
- 6. Battery
- 8. Smart card reader
- 10. Touchpad
- 12. Display assembly
- 14. Memory module
- 16. Wireless card

- 17. Solid-state drive thermal shield
- 19. Power-button bard

- 18. Solid-state drive

 **NOTE:** Dell provides a list of components and their part numbers for the original system configuration purchased. These parts are available according to warranty coverages purchased by the customer. Contact your Dell sales representative for purchase options.



# Removing and installing Customer Replaceable Units (CRUs)

The replaceable components in this chapter are Customer Replaceable Units (CRUs).

 **CAUTION:** Customers can replace only the Customer Replaceable Units (CRUs) following the safety precautions and replacement procedures.

 **NOTE:** The images in this document may differ from your computer depending on the configuration you ordered.

## SIM card tray

### Removing the SIM card tray

#### Prerequisites

1. Follow the procedure in [Before working inside your computer](#).

#### About this task

The following images indicate the location of the SIM card tray and provide a visual representation of the removal procedure.

This procedure is applicable to computers shipped with WWAN card only.

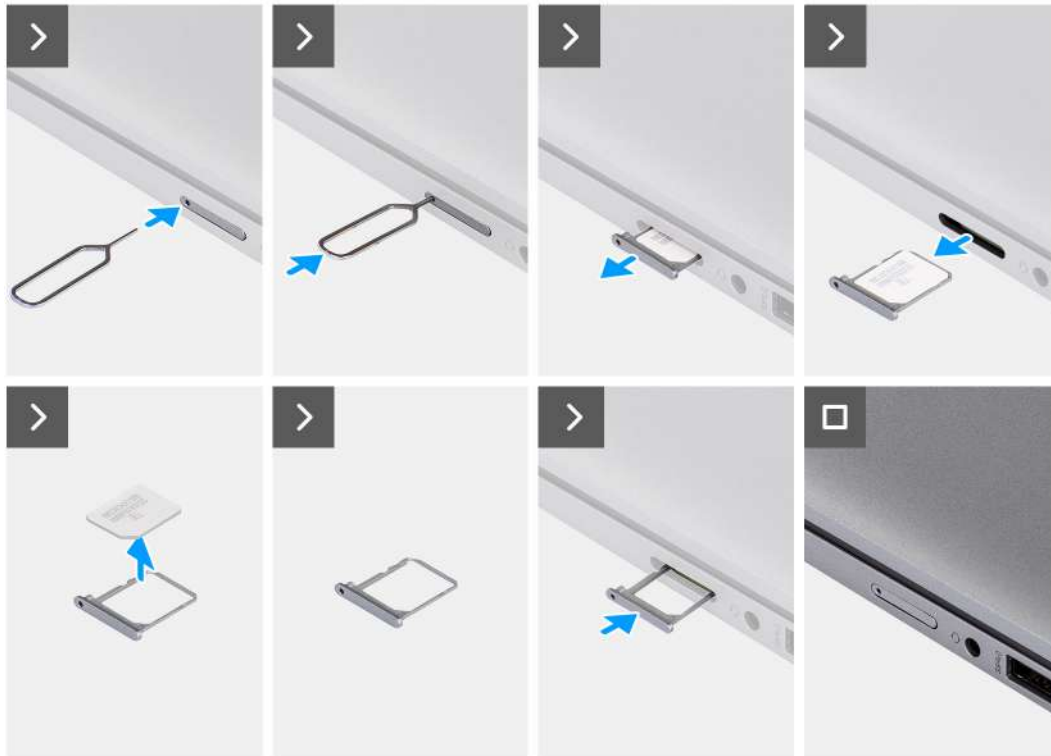

**Figure 2. Removing the SIM card tray**

### Steps

1. Insert a pin into the release hole to release the SIM card tray.
2. Push the pin to disengage the lock, and eject the SIM card tray.
3. Slide the SIM card tray out of the slot on the computer.
4. Remove the SIM card from the SIM card tray.
5. Slide and push the SIM card tray back into the slot.

## Installing the SIM card tray

### Prerequisites

If you are replacing a component, remove the existing component before performing the installation procedure.

### About this task

The following images indicate the location of the SIM card tray and provide a visual representation of the removal procedure.

This procedure is applicable to computers shipped with WWAN card only.

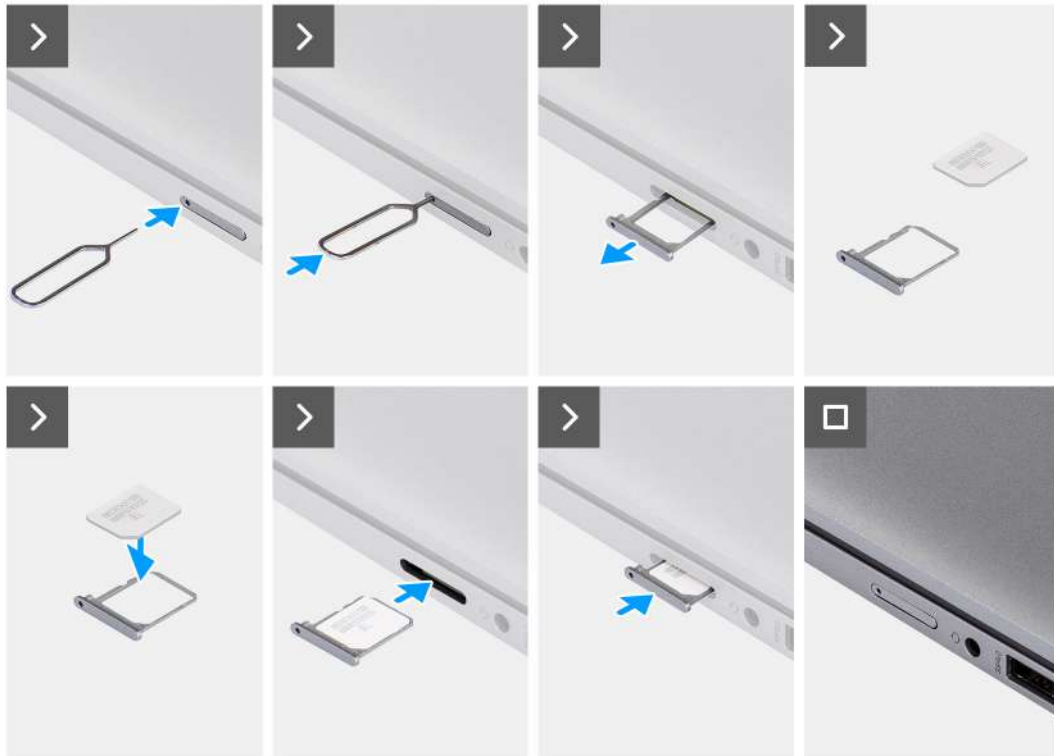

Figure 3. Installing the SIM card tray

#### Steps

1. Align and place the SIM card in the dedicated slot on the SIM card tray.
2. Slide the SIM card tray into the slot in the computer, and push it to lock in place.

#### Next steps

1. Follow the procedure in [After working inside your computer](#).

## Base cover

### Removing the base cover

#### Prerequisites

1. Follow the procedure in [Before working inside your computer](#).

**NOTE:** Ensure that your computer is in Service Mode. For more information, see [Before working inside your computer](#).

**CAUTION:** If you are unable to turn on the computer, if your computer is unable to enter Service Mode, or the computer does not support Service Mode, proceed to disconnect the battery cable.

2. Remove the [nanoSIM card](#).

## About this task

**NOTE:** Before removing the base cover, ensure that there is no SD card installed in the SD card slot on your computer.

The following images indicate the location of the base cover and provide a visual representation of the removal procedure.

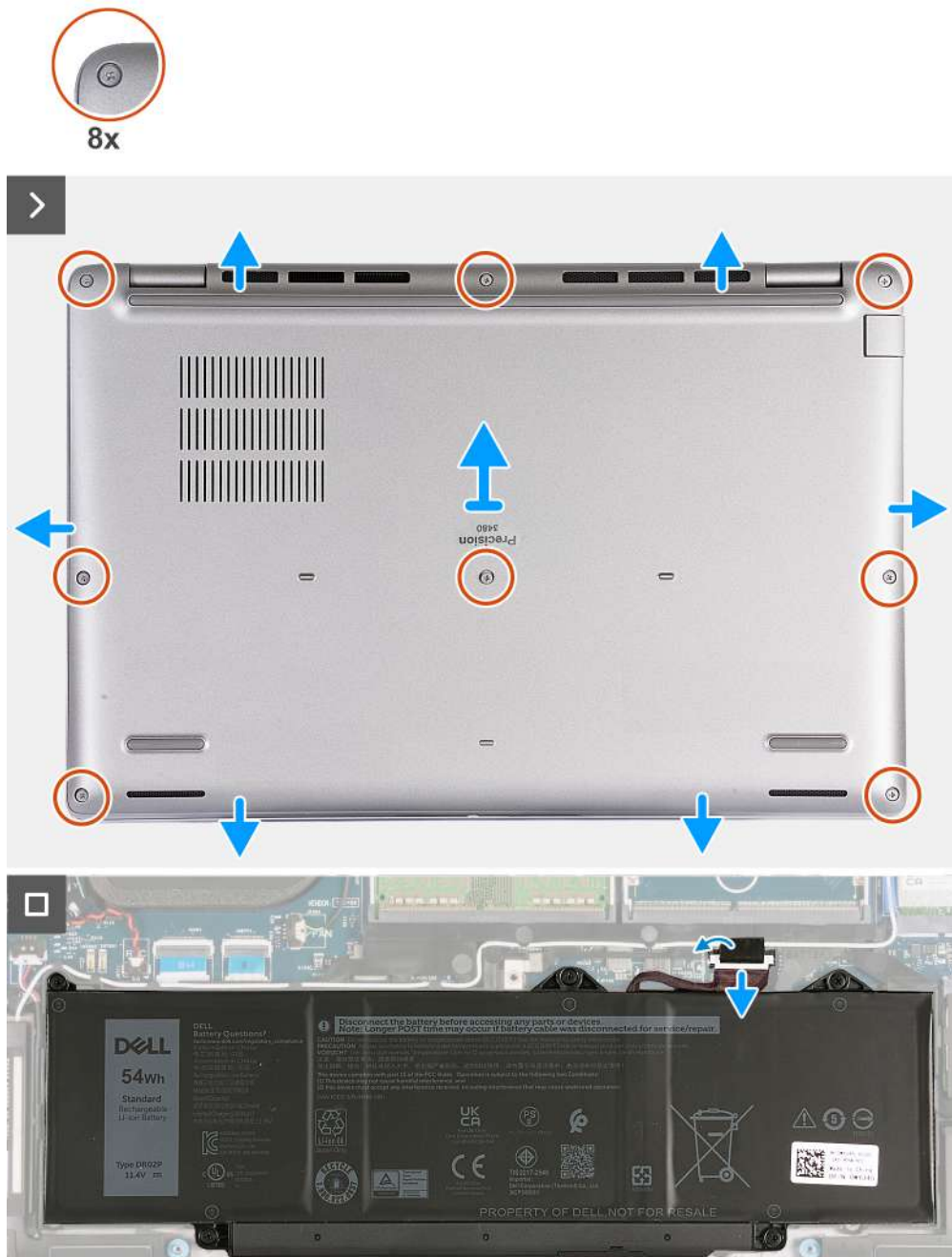

**Figure 4. Removing the base cover**

## Steps

1. Loosen the eight captive screws that secure the base cover to the palm-rest assembly.
2. Using a plastic scribe, pry open the base cover from the recesses located in the U-shaped indents at the top edge of the base cover near the hinges.
3. Lift the base cover off the palm-rest assembly.

**NOTE:** Ensure that your computer is in Service Mode. If your computer is unable to enter Service Mode, disconnect the battery cable from the system board. To disconnect the battery cable, follow step 4 to step 6.

4. Disconnect the battery cable from the system board.
5. Peel the tape that secures the battery cable to the battery.
6. Press and hold the power button for five seconds to ground the computer and drain the flea power.

## Installing the base cover

### Prerequisites

If you are replacing a component, remove the existing component before performing the installation process.

### About this task

The following images indicate the location of the base cover and provide a visual representation of the installation procedure.

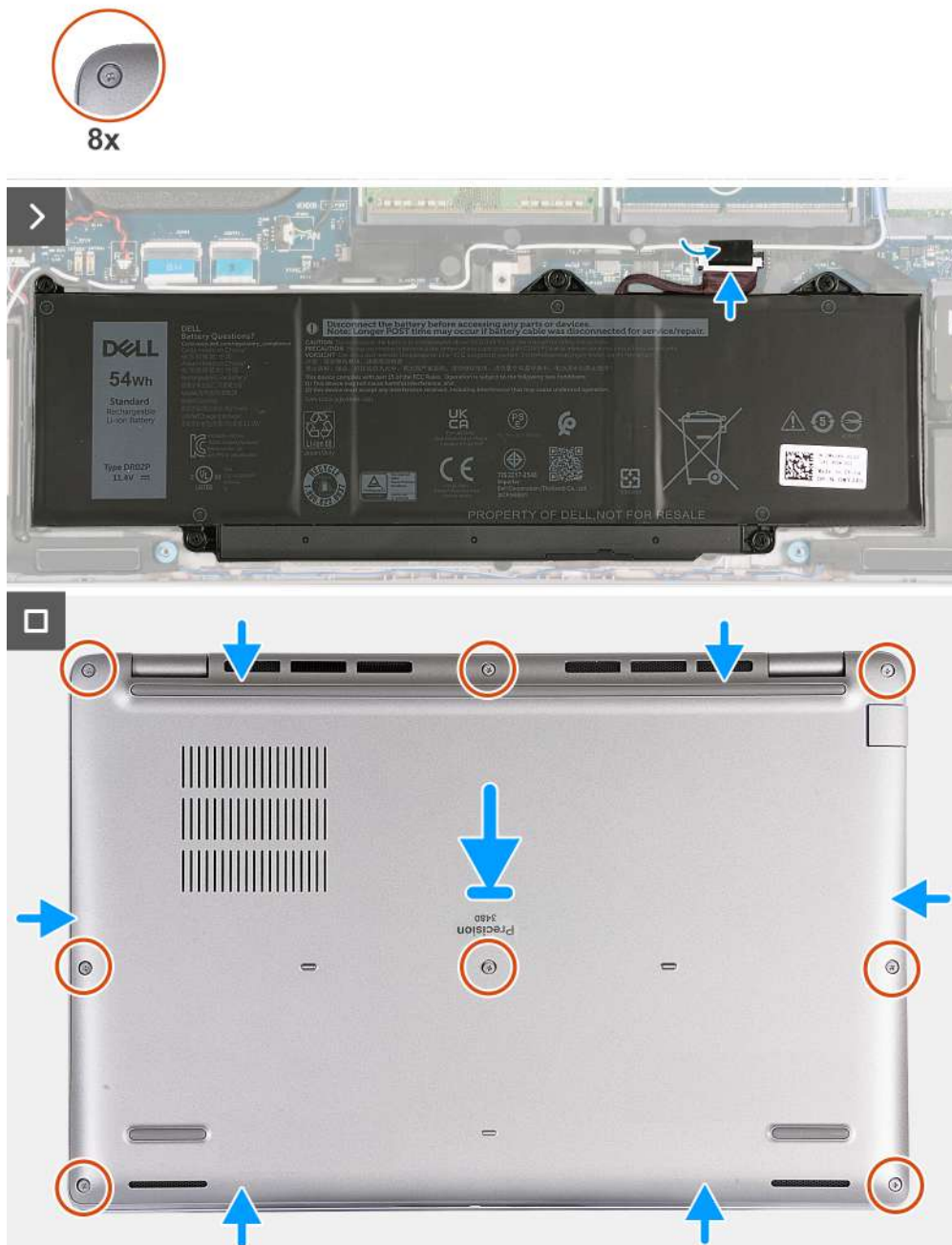

Figure 5. Installing the base cover

**NOTE:**

If battery is not a pre-requisite and if you have disconnected the battery cable, ensure to connect the battery cable. To connect the battery cable, follow step 1 and step 2 in the procedure.

**Steps**

1. Connect the battery cable to the system board.
2. Adhere the tape that secures the battery cable to the battery.
3. Align and place the base cover into slots on the palm-rest assembly.
4. Tighten the eight captive screws that secure the base cover to the palm-rest assembly.

**Next steps**

1. Install the [nanoSIM card](#).
2. Follow the procedure in [After working inside your computer](#).

**NOTE:** Ensure that your computer is in Service Mode. For more information, see [Before working inside your computer](#).

## Memory modules

### Removing the memory module

**Prerequisites**

1. Follow the procedure in [Before working inside your computer](#).
2. Remove the [nanoSIM card](#).
3. Remove the [base cover](#).

**About this task**

The following image(s) indicate the location of the memory module and provides a visual representation of the removal procedure.

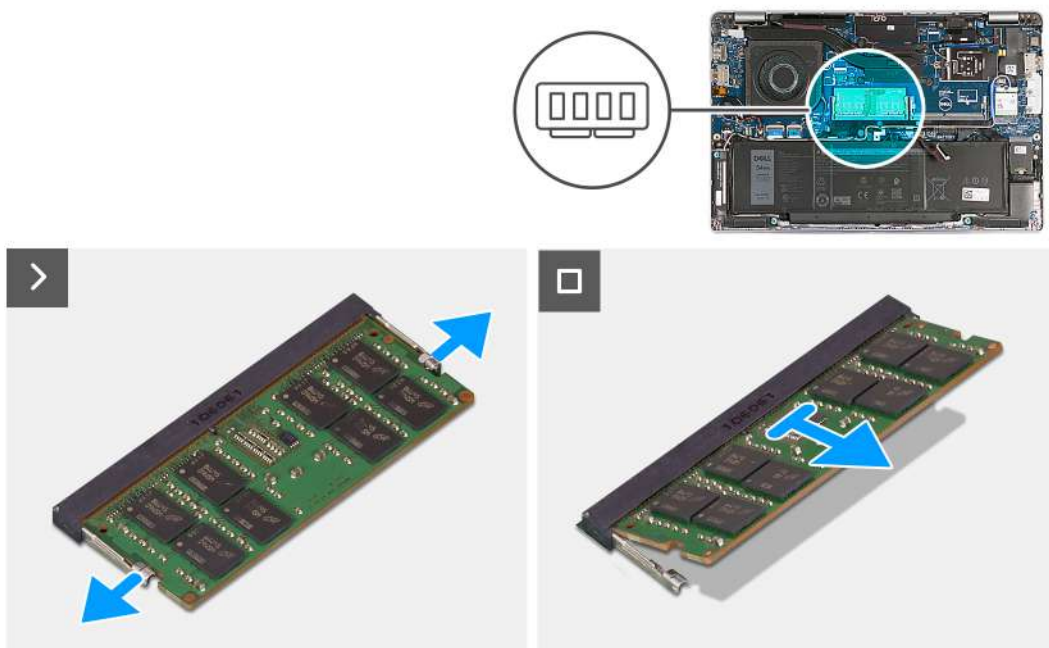

**Figure 6. Removing the memory module**

### Steps

1. Using your fingertips, spread apart the securing clips on the memory-module slot until the memory module pops up.
2. Slide and remove the memory module from the memory-module slot on the system board.

**i** **NOTE:** Repeat step 1 and step 2 if there is more than one memory module installed on your computer.

## Installing the memory module

### Prerequisites

If you are replacing a component, remove the existing component before performing the installation process.

### About this task

The following image(s) indicate the location of the memory module and provides a visual representation of the installation procedure.

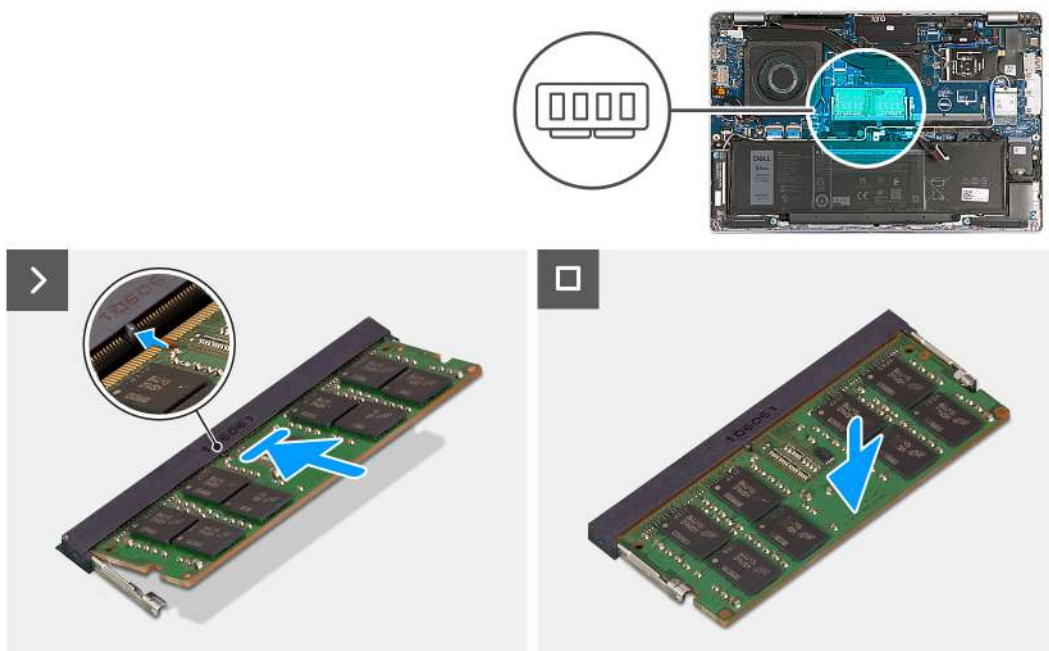

**Figure 7. Installing the memory module**

### Steps

1. Align the notch on the memory module with the tab on the memory-module slot.
2. Slide the memory module firmly into the slot at an angle and press the memory module down until it clicks into place.

**i** **NOTE:** If you do not hear the click, remove the memory module and reinstall it.

### Next steps

1. Install the [base cover](#).
2. Install the [nanoSIM card](#).
3. Follow the procedure in [After working inside your computer](#).

# Solid-state drive

## Removing the M.2 2230 solid-state drive

### Prerequisites

1. Follow the procedure in [Before working inside your computer](#).
2. Remove the [nanoSIM card](#).
3. Remove the [base cover](#).

### About this task

The following image(s) indicate the location of the M.2 2230 solid-state drive and provides a visual representation of the removal procedure.

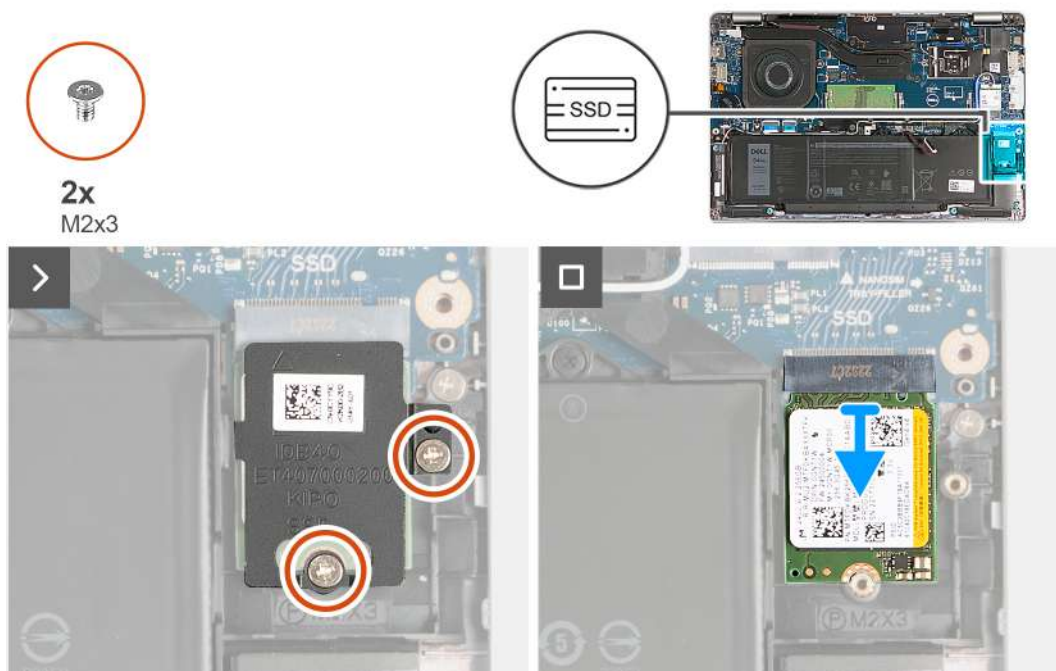

Figure 8. Removing the M.2 2230 solid-state drive

### Steps

1. Remove the two screws (M2x3) that secure the solid-state drive thermal shield to the palm-rest assembly.
2. Slide and lift the solid-state drive thermal shield off the palm-rest assembly.
3. Slide and lift the M.2 2230 solid-state drive off the solid-state drive slot.

## Installing the M.2 2230 solid-state drive

### Prerequisites

If you are replacing a component, remove the existing component before performing the installation process.

### About this task

The following image(s) indicate the location of the M.2 2230 solid-state drive and provides a visual representation of the installation procedure.



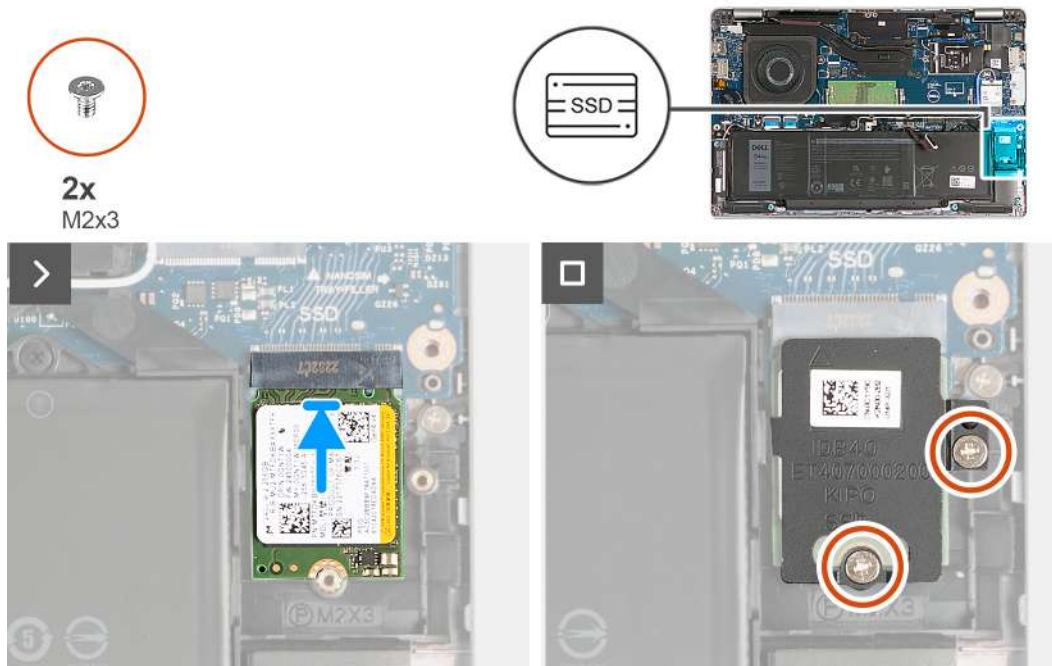

**Figure 9. Installing the M.2 2230 solid-state drive**

### Steps

1. Align the notch on the solid-state drive with the tab on the solid-state drive slot.
2. Slide the solid-state drive into the solid-state drive slot.
3. Align the tab on the thermal shield with the recess on the inner frame.
4. Align the screw hole on the solid-state drive thermal shield with the screw hole on the solid-state drive and palm-rest assembly.
5. Replace the two screws (M2x3) that secures the M.2 2230 solid-state drive thermal shield to the solid-state drive and palm-rest assembly.

### Next steps

1. Install the [base cover](#).
2. Install the [nanoSIM card](#).
3. Follow the procedure in [After working inside your computer](#).

## Wireless card

### Removing the wireless card

#### Prerequisites

1. Follow the procedure in [Before working inside your computer](#).
2. Remove the [nanoSIM card](#).
3. Remove the [base cover](#).

#### About this task

The following image(s) indicate the location of the wireless card and provides a visual representation of the removal procedure.



**Figure 10. Removing the wireless card**

**Steps**

1. Remove the captive screw that secures the wireless-card bracket to the wireless card and palm-rest assembly.
2. Lift the wireless-card bracket off the wireless card.
3. Disconnect the antenna cables from the wireless card.
4. Peel the wireless card from the thermal pad and remove the wireless card off the wireless-card slot.

## Installing the wireless card

**Prerequisites**

If you are replacing a component, remove the existing component before performing the installation process.

**About this task**

The following image(s) indicate the location of the wireless card and provides a visual representation of the installation procedure.

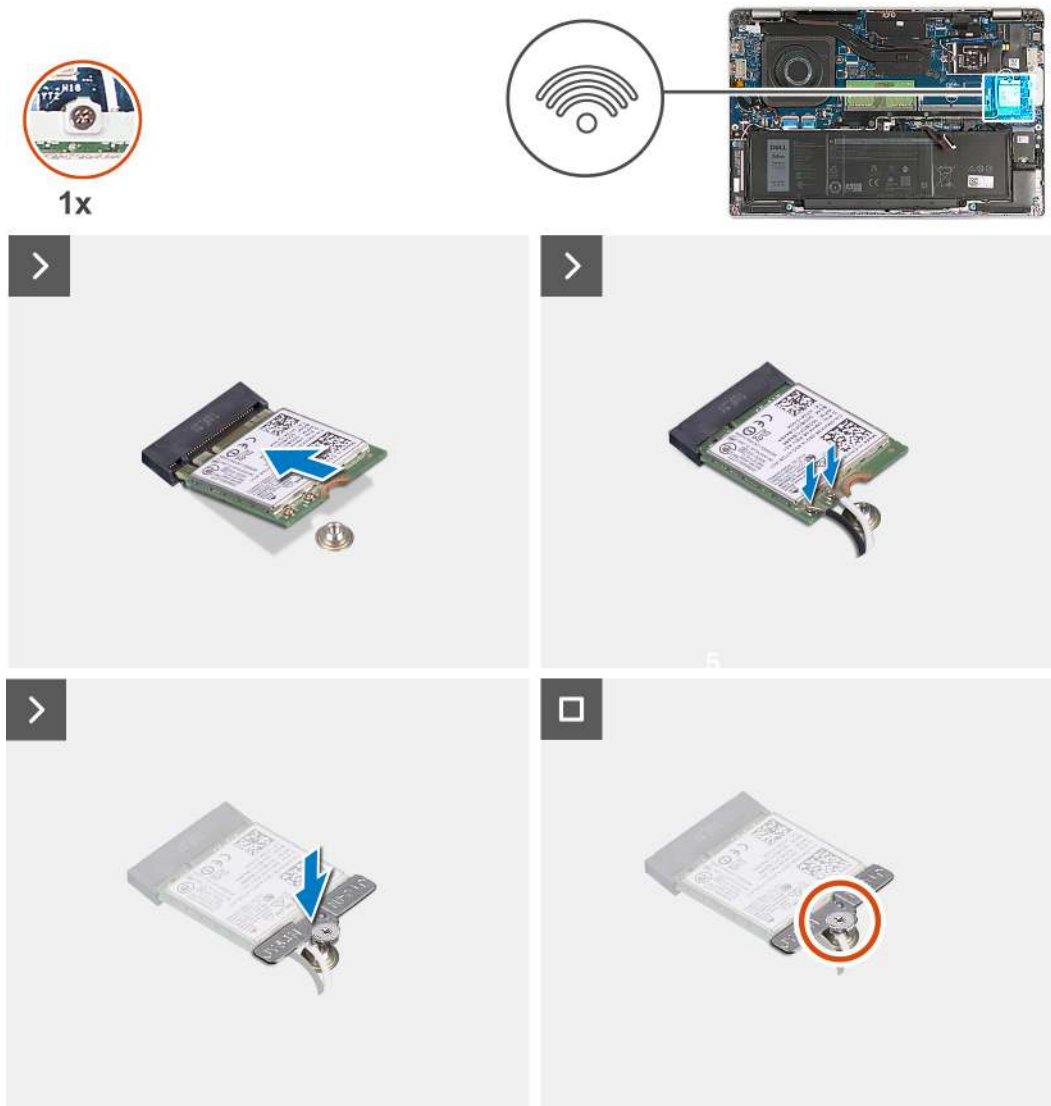

**Figure 11. Installing the wireless card**

**Steps**

1. Connect the antenna cables to the wireless card.

The following table provides the antenna-cable color scheme for the wireless card that is supported by your computer.

**Table 33. Antenna-cable color scheme**

Connectors on the wireless card	Antenna-cable color	Silkscreen marking	
Main	White	MAIN	△ (white triangle)
Auxiliary	Black	AUX	▲ (black triangle)

2. Align the notch on the wireless card with the tab on the wireless-card slot. .
3. Adhere the wireless card at an angle into the wireless-card slot
4. Align the screw hole on the wireless-card bracket with the screw hole on the wireless card and palm-rest assembly.
5. Tighten the captive screw that secures the wireless-card bracket to the wireless card and the palm-rest assembly.

### Next steps

1. Install the [base cover](#).
2. Install the [nanoSIM card](#).
3. Follow the procedure in [After working inside your computer](#).

## Wireless Wide Area Network (WWAN) card

### Removing the WWAN card

#### Prerequisites

1. Follow the procedure in [Before working inside your computer](#).
2. Remove the [nanoSIM card](#).
3. Remove the [base cover](#).

#### About this task

 **NOTE:** The WWAN card is available only on certain configurations.

The following image(s) indicate the location of the WWAN card and provides a visual representation of the removal procedure.

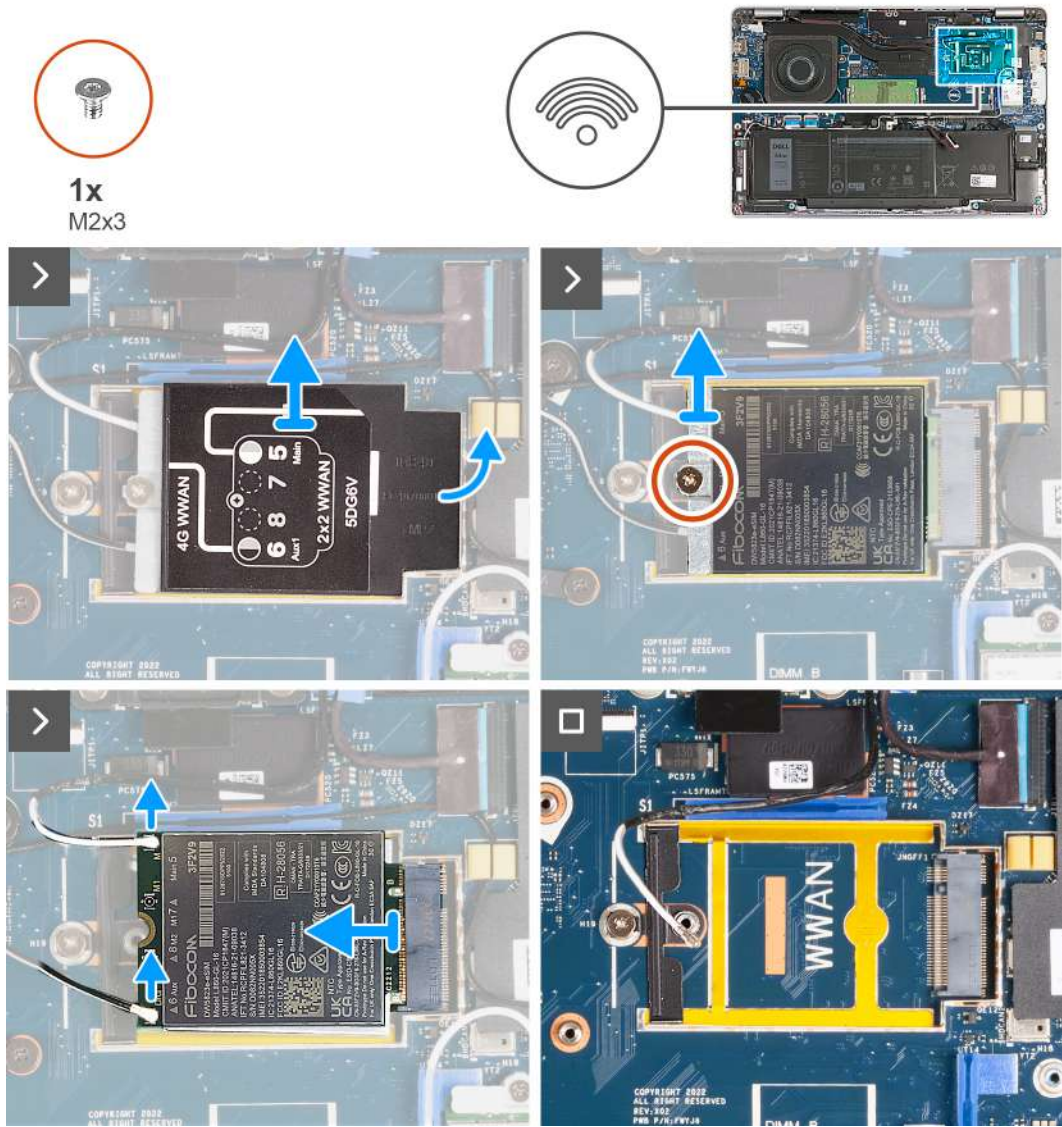
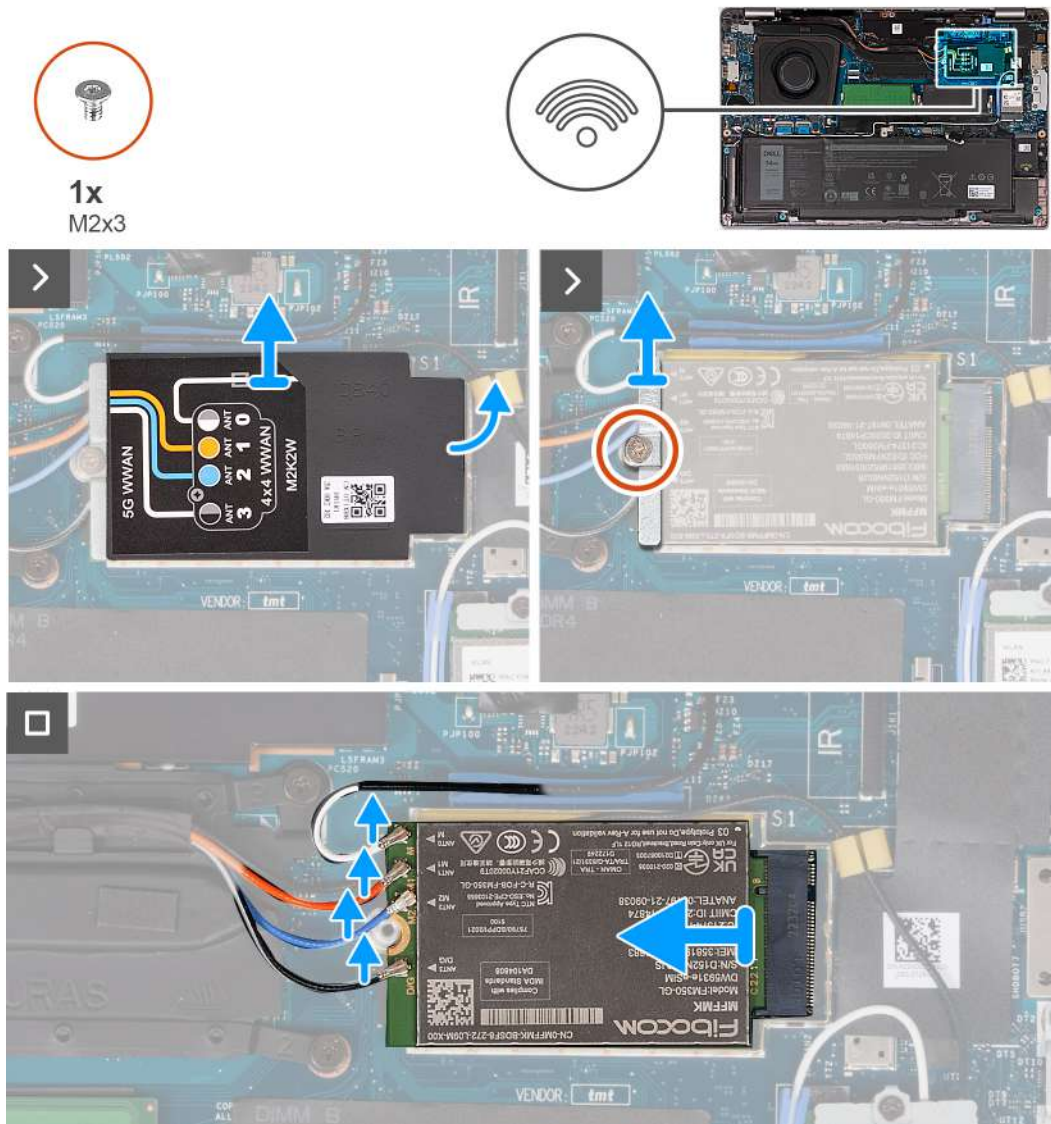

Figure 12. Removing the WWAN card - For computers shipped with 4G card



**Figure 13. Removing the WWAN card - For computers shipped with 5G card**

### Steps

1. Using plastic scribe, pry open the WWAN-card shield that secures the WWAN card to the palm-rest assembly.
2. Lift the WWAN-card shield off the WWAN card.
3. Remove the screw (M2x3) that secures the WWAN-card bracket to the WWAN card and palm-rest assembly.
4. Lift the WWAN-card bracket off the WWAN card and palm-rest assembly.
5. Disconnect the antenna cables from the WWAN card.
6. Remove the WWAN card off the WWAN-card slot on the system board.

## Installing the WWAN card

### Prerequisites

If you are replacing a component, remove the existing component before performing the installation process.

### About this task

**NOTE:** The WWAN card is available only on certain configurations.

The following image(s) indicate the location of the WWAN card and provides a visual representation of the installation procedure.

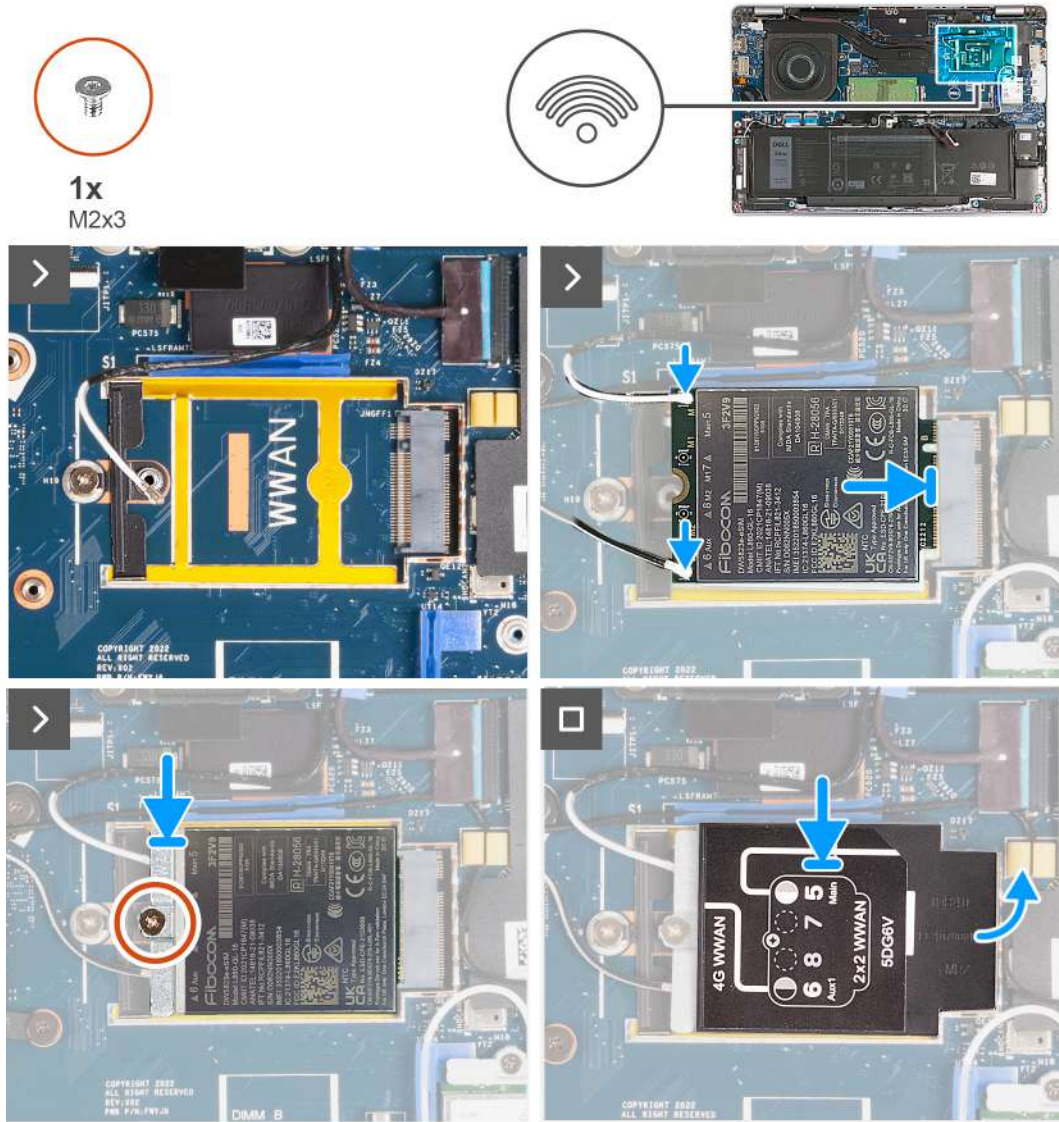

Figure 14. Installing the WWAN card - For computers shipped with 4G card

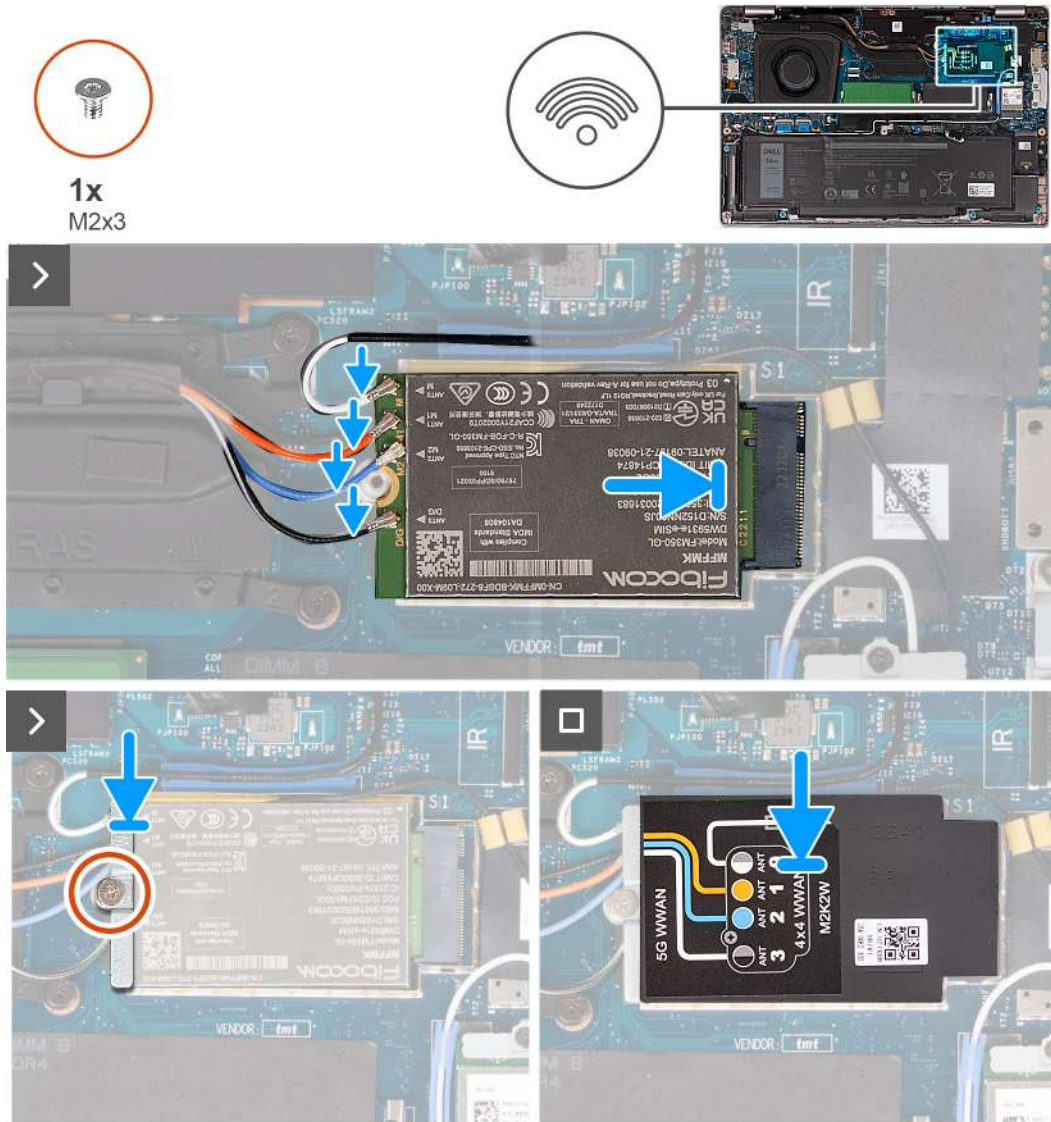

Figure 15. Installing the WWAN card - For computers shipped with 5G card

**Steps**

1. Connect the antenna cables to the WWAN card.

The following table provides the antenna-cable color scheme for the WWAN card that is supported by your computer.

**Table 34. Antenna-cable color scheme**

Connectors on the WWAN card	Antenna-cable color	Silkscreen marking	
Main	White	MAIN	△ (white triangle)
Auxiliary	Black	AUX	▲ (black triangle)

**Table 35. Antenna-cable color scheme**

Connectors on the WWAN card	Antenna-cable color	Silkscreen marking
ANT0	White	M
ANT1	Orange	M1
ANT2	Blue	M2



**Table 35. Antenna-cable color scheme (continued)**

Connectors on the WWAN card	Antenna-cable color	Silkscreen marking
ANT3	Black	D/G

2. Align the notch on the WWAN card with the tab on the WWAN-card slot.
3. Insert the WWAN card at an angle into the WWAN-card slot.
4. Align the screw hole on the WWAN-card bracket with the screw hole on the WWAN card and palm-rest assembly.
5. Replace the screw (M2x3) that secures the wireless-card bracket to the wireless card and the palm-rest assembly.
6. Align and place the WWAN-card shield on the WWAN card.

**Next steps**

1. Install the [base cover](#).
2. Install the [nanoSIM card](#).
3. Follow the procedure in [After working inside your computer](#).

## Fan

### Removing the fan

**Prerequisites**

1. Follow the procedure in [Before working inside your computer](#).
2. Remove the [nanoSIM card](#).
3. Remove the [base cover](#).

**About this task**

The following image(s) indicate the location of the fan and provides a visual representation of the removal procedure.

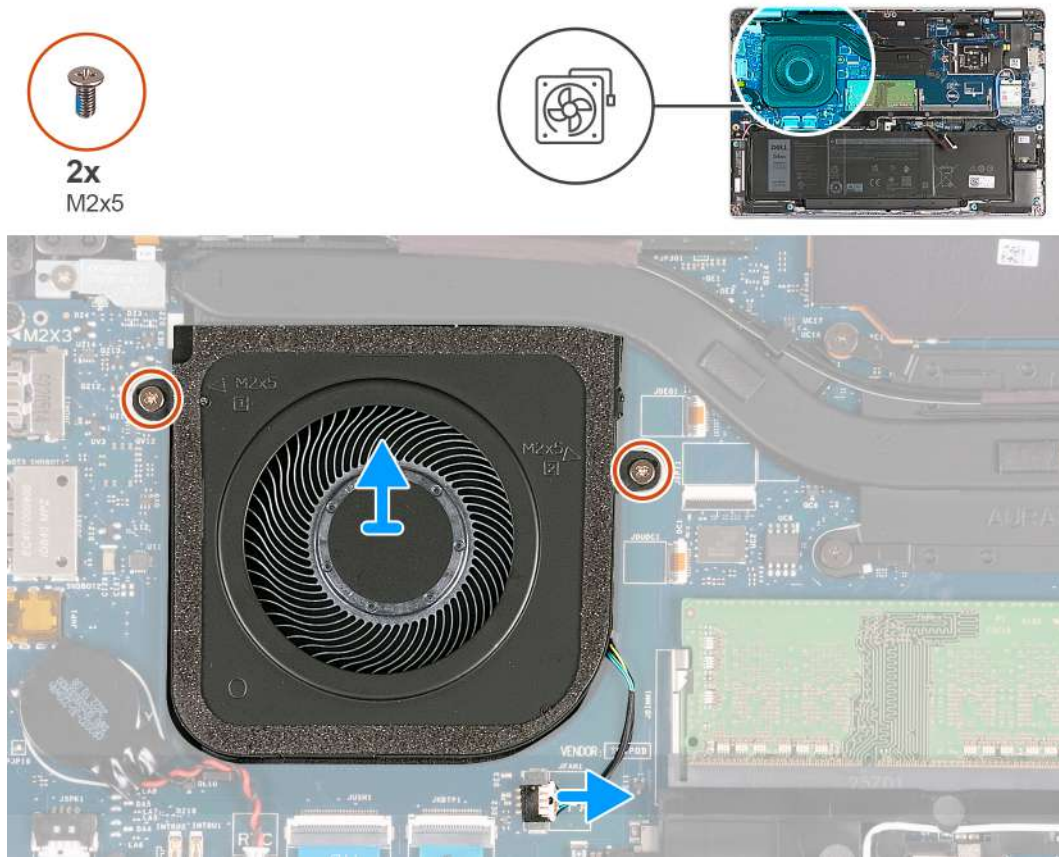

**Figure 16. Removing the fan**

### Steps

1. Disconnect the fan cable from the system board.
2. Remove the two screws (M2x5) that secure the fan to the palm-rest assembly.
3. Lift the fan off the palm-rest assembly.

## Installing the fan

### Prerequisites

If you are replacing a component, remove the existing component before performing the installation process.

### About this task

The following image(s) indicate the location of the fan and provides a visual representation of the installation procedure.

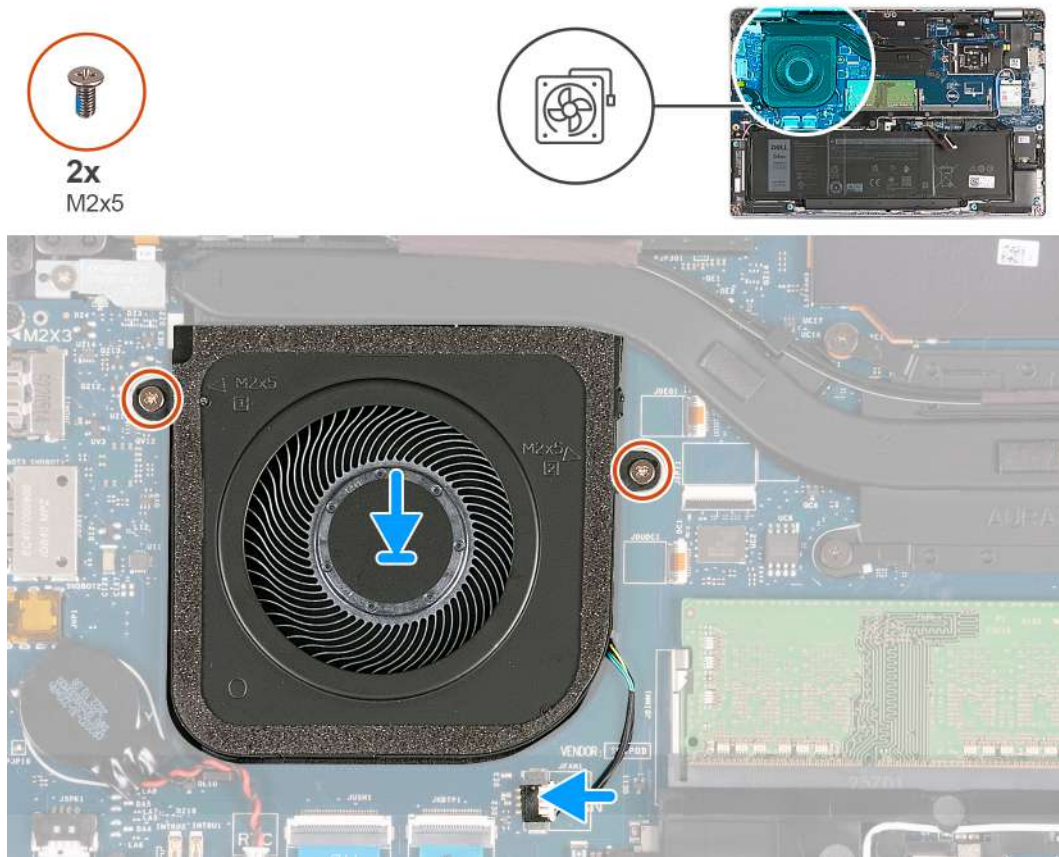

**Figure 17. Installing the fan**

### Steps

1. Align the screw holes on the fan with the screw holes on the palm-rest assembly.
2. Replace the two screws (M2x5) that secure the fan to the palm-rest assembly.
3. Connect the fan cable to the system board.

### Next steps

1. Install the [base cover](#).
2. Install the [nanoSIM card](#).
3. Follow the procedure in [After working inside your computer](#).

# Removing and installing Field Replaceable Units (FRUs)

The replaceable components in this chapter are Field Replaceable Units (FRUs).

**CAUTION:** The information in this section is intended for authorized service technicians only.

**CAUTION:** To avoid any potential damage to the component or loss of data, ensure that an authorized service technician replaces the Field Replaceable Units (FRUs).

**CAUTION:** Dell Technologies recommends that this set of repairs, if needed, to be conducted by trained technical repair specialists.

**CAUTION:** As a reminder, your warranty does not cover damages that may occur during the courses of FRU repairs that are not authorized by Dell Technologies.

**NOTE:** The images in this document may differ from your computer depending on the configuration you ordered.

## Battery

### Lithium-ion battery precautions

**CAUTION:**

- Exercise caution when handling Lithium-ion batteries.
- Discharge the battery completely before removing it. Disconnect the AC power adapter from the system and operate the computer solely on battery power—the battery is fully discharged when the computer no longer turns on when the power button is pressed.
- Do not crush, drop, mutilate, or penetrate the battery with foreign objects.
- Do not expose the battery to high temperatures, or disassemble battery packs and cells.
- Do not apply pressure to the surface of the battery.
- Do not bend the battery.
- Do not use tools of any kind to pry on or against the battery.
- Ensure any screws during the servicing of this product are not lost or misplaced, to prevent accidental puncture or damage to the battery and other system components.
- If the battery gets stuck inside your computer as a result of swelling, do not try to release it as puncturing, bending, or crushing a lithium-ion battery can be dangerous. In such an instance, contact Dell technical support for assistance. See [www.dell.com/contactdell](http://www.dell.com/contactdell).
- Always purchase genuine batteries from [www.dell.com](http://www.dell.com) or authorized Dell partners and resellers.
- Swollen batteries should not be used and should be replaced and disposed properly. For guidelines on how to handle and replace swollen Lithium-ion batteries, see [Handling swollen Lithium-ion batteries](#).

### Removing the battery

**CAUTION:** The information in this section is intended for authorized service technicians only.

### Prerequisites

1. Follow the procedure in [Before working inside your computer](#).
2. Remove the [nanoSIM card](#).
3. Remove the [base cover](#).

### About this task

The following image(s) indicate the location of the battery and provides a visual representation of the removal procedure.

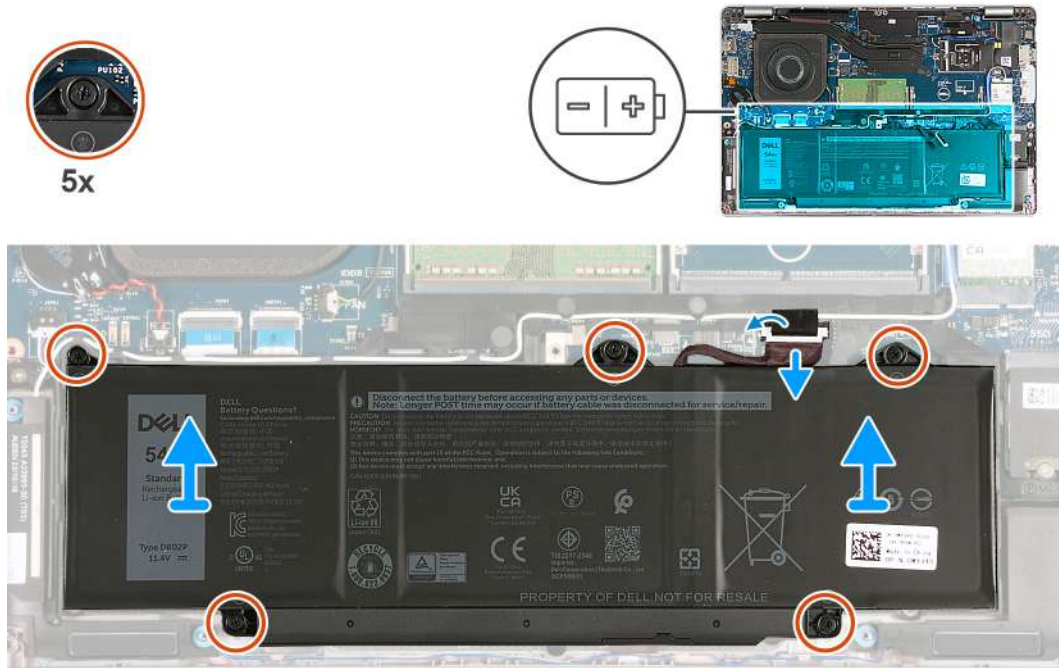

**Figure 18. Removing the battery**

### Steps

1. Peel the tape that secures the battery cable to the palm-rest assembly.
2. Disconnect the battery cable from the system board (if not disconnected earlier).
3. Loosen the five captive screws that secure the battery to the palm-rest assembly.
4. Lift the battery off the palm-rest assembly.

## Installing the battery

**CAUTION:** The information in this section is intended for authorized service technicians only.

### Prerequisites

If you are replacing a component, remove the existing component before performing the installation process.

### About this task

The following image(s) indicate the location of the battery and provides a visual representation of the installation procedure.

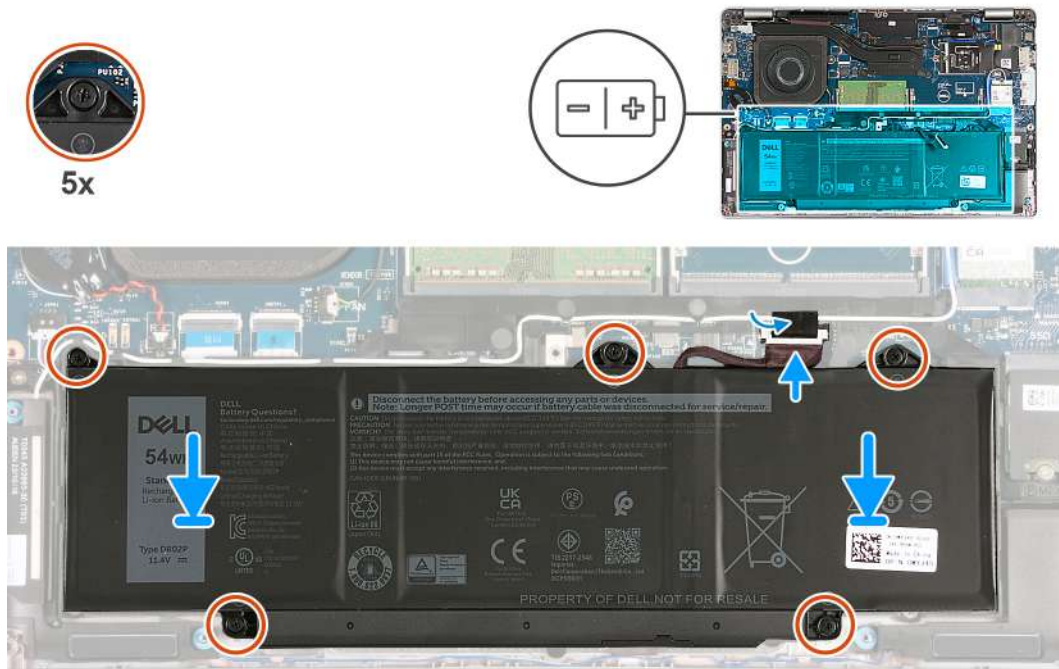

**Figure 19. Installing the battery**

### Steps

1. Using the alignment posts, place the battery on the palm-rest assembly.
2. Align the screw holes on the battery with the screw holes on the palm-rest assembly.
3. Tighten the five captive screws that secure the battery to the palm-rest assembly.
4. Connect the battery cable to the system board.
5. Adhere the tape that secures the battery cable to the battery.

### Next steps

1. Install the [base cover](#).
2. Install the [nanoSIM card](#).
3. Follow the procedure in [After working inside your computer](#).

## Coin-cell battery

### Removing the coin-cell battery

**CAUTION:** The information in this section is intended for authorized service technicians only.

#### Prerequisites

1. Follow the procedure in [Before working inside your computer](#).
2. Remove the [nanoSIM card](#).
3. Remove the [base cover](#).

#### About this task

**WARNING:** Removing the coin-cell battery resets the BIOS setup program's settings to default. It is recommended that you note the BIOS setup program's settings before removing the coin-cell battery.

The following image(s) indicate the location of the coin-cell battery and provides a visual representation of the removal procedure.

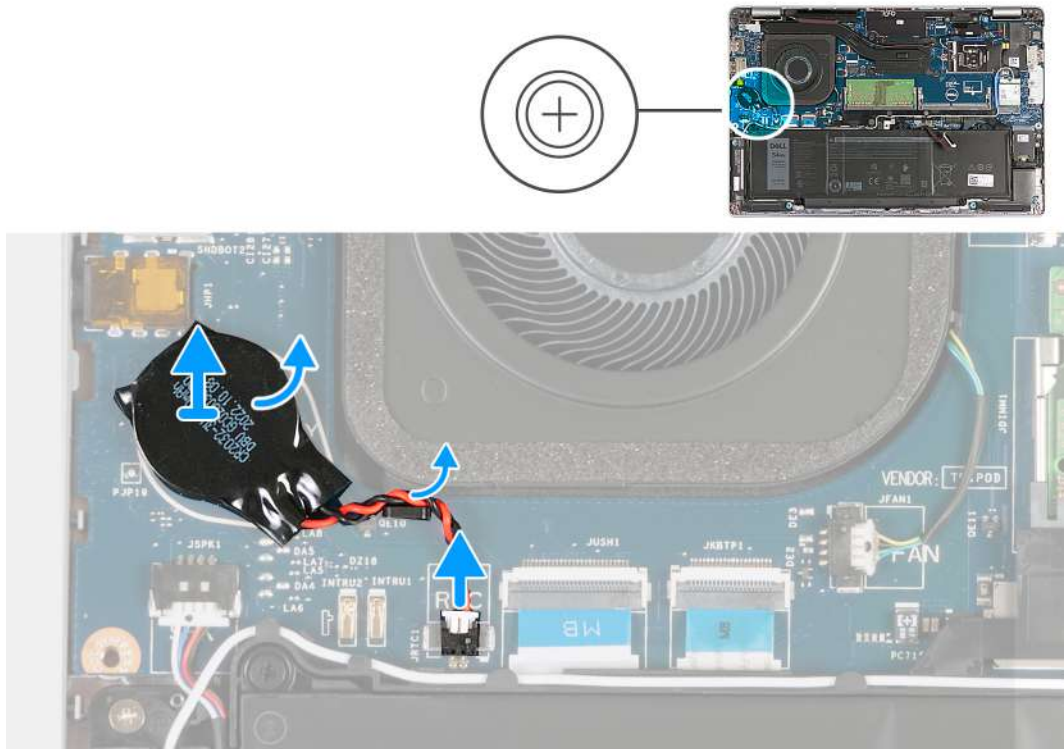

**Figure 20. Removing the coin-cell battery**

**Steps**

1. Disconnect the coin-cell battery cable from the system board.
2. Remove the coin-cell battery cable from the routing guide on the palm-rest assembly.
3. Peel the coin-cell battery, along with its cable, off the system board.

## Installing the coin-cell battery

**CAUTION:** The information in this section is intended for authorized service technicians only.

**Prerequisites**

If you are replacing a component, remove the existing component before performing the installation process.

**About this task**

The following image(s) indicate the location of the coin-cell battery and provides a visual representation of the installation procedure.

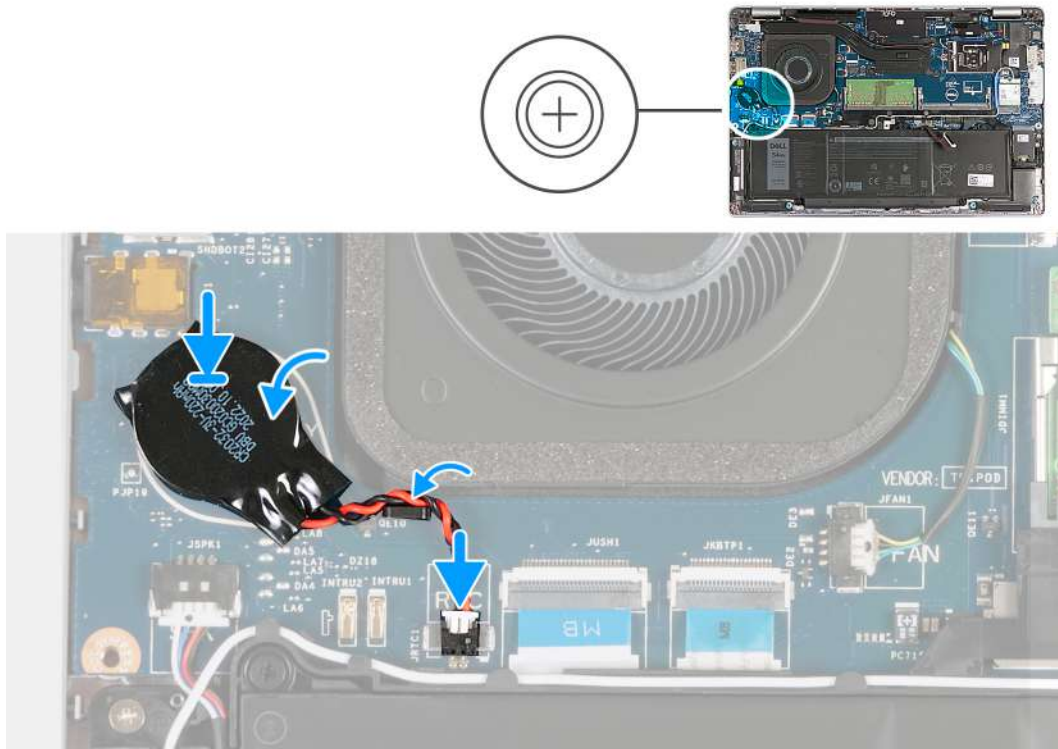

**Figure 21. Installing the coin-cell battery**

**Steps**

1. Adhere the coin-cell battery on to the coin-cell battery slot on the system board.
2. Route the coin-cell battery cable through the routing guide on the palm-rest assembly.
3. Connect the coin-cell battery cable to the system board.

**Next steps**

1. Install the [base cover](#).
2. Install the [nanoSIM card](#).
3. Follow the procedure in [After working inside your computer](#).

## Heat sink

### Removing the heat sink - for computers shipped with integrated graphics card

**⚠ CAUTION:** The information in this section is intended for authorized service technicians only.

**Prerequisites**

1. Follow the procedure in [Before working inside your computer](#).
2. Remove the [nanoSIM card](#).
3. Remove the [base cover](#).
4. Remove the [WWAN card](#).

**About this task**

**i NOTE:** The heat sink may become hot during normal operation. Allow sufficient time for the heat sink to cool before you touch it.



**NOTE:** For maximum cooling of the processor, do not touch the heat transfer areas on the heat sink. The oils in your skin can reduce the heat transfer capability of the thermal grease.

The following images indicate the location of the heat sink and provide a visual representation of the removal procedure.

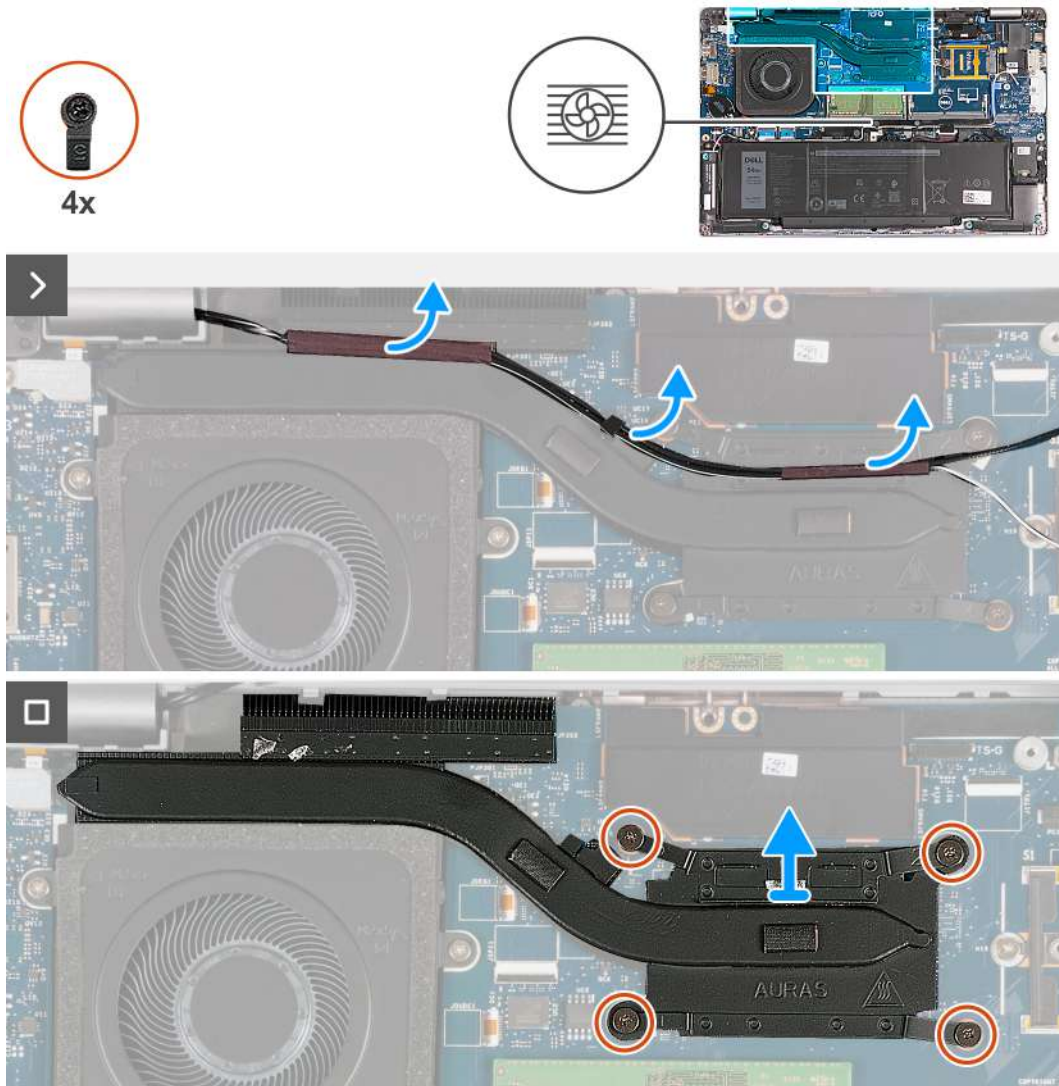
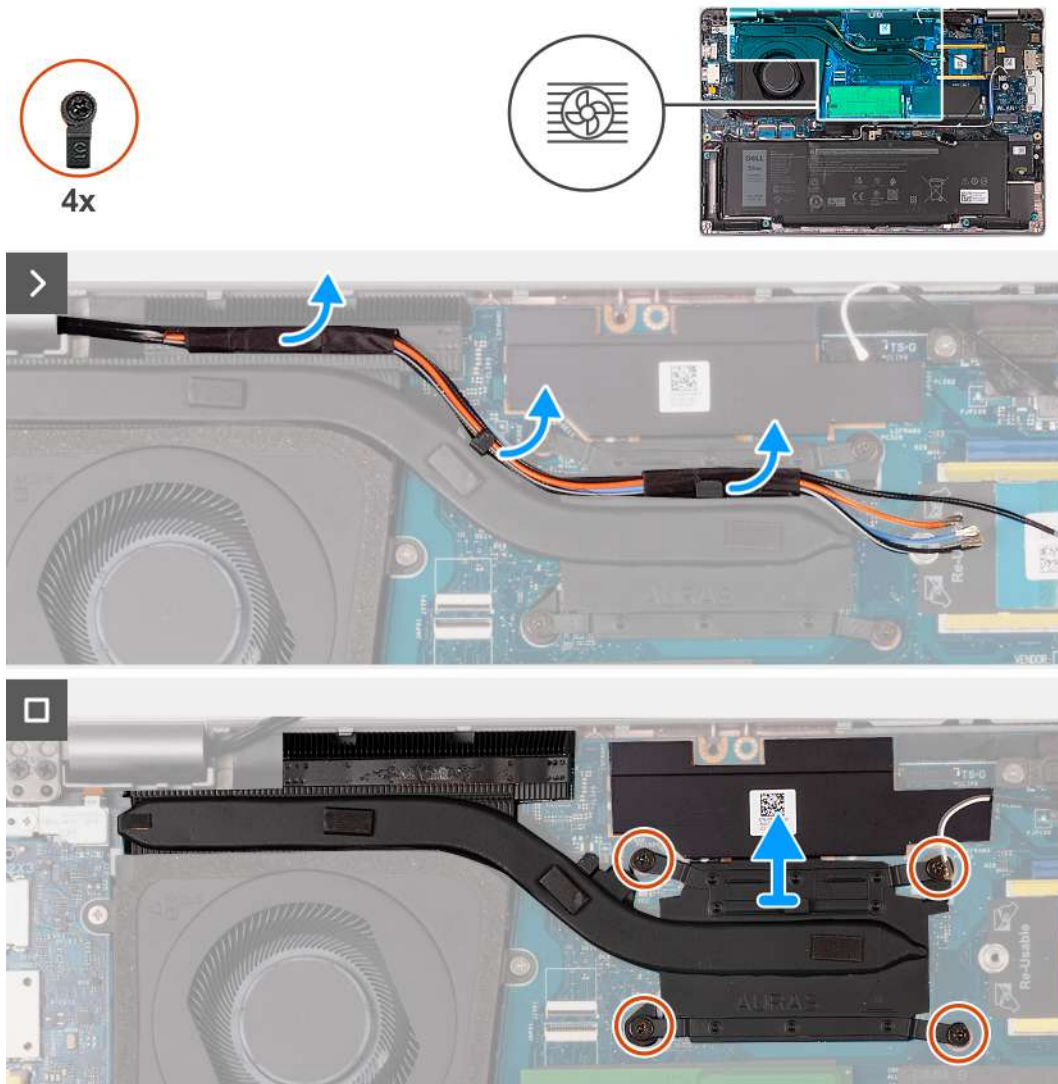

Figure 22. Removing the heat sink - For computers shipped with 4G card



**Figure 23. Removing the heat sink - For computers shipped with 5G card**

**NOTE:** For configurations shipped with a P28 UMA system board, the power shielding cover is a pre-requisite for removing the heat sink.

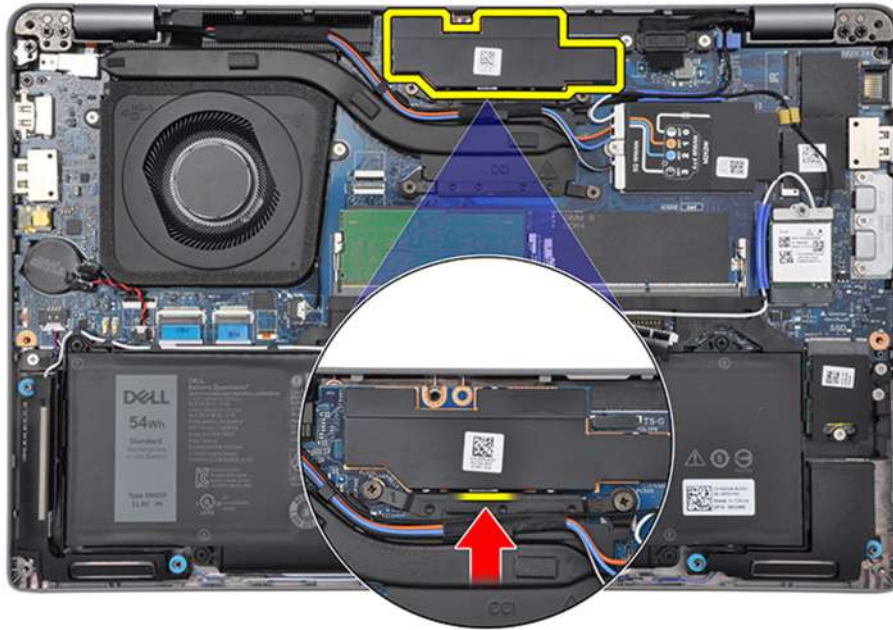

Figure 24. Power shielding cover

### Steps

1. Peel the antenna cables and remove the cables from the routing guides on the heat sink.
2. Loosen the four captive screws in the reverse sequential order mentioned on the heat sink [4 > 3 > 2 > 1].  
**i** **NOTE:** The number of screws varies depending on the configuration ordered.
3. Lift the heat sink from the system board.

## Installing the heat sink - for computers shipped with integrated graphics card

**⚠ CAUTION:** The information in this section is intended for authorized service technicians only.

### Prerequisites

If you are replacing a component, remove the existing component before performing the installation process.

### About this task

**i** **NOTE:** If either the system board or the heat sink is replaced, use the thermal grease provided in the kit to ensure that thermal conductivity is achieved.

The following images indicate the location of the heat sink and provide a visual representation of the installation procedure.

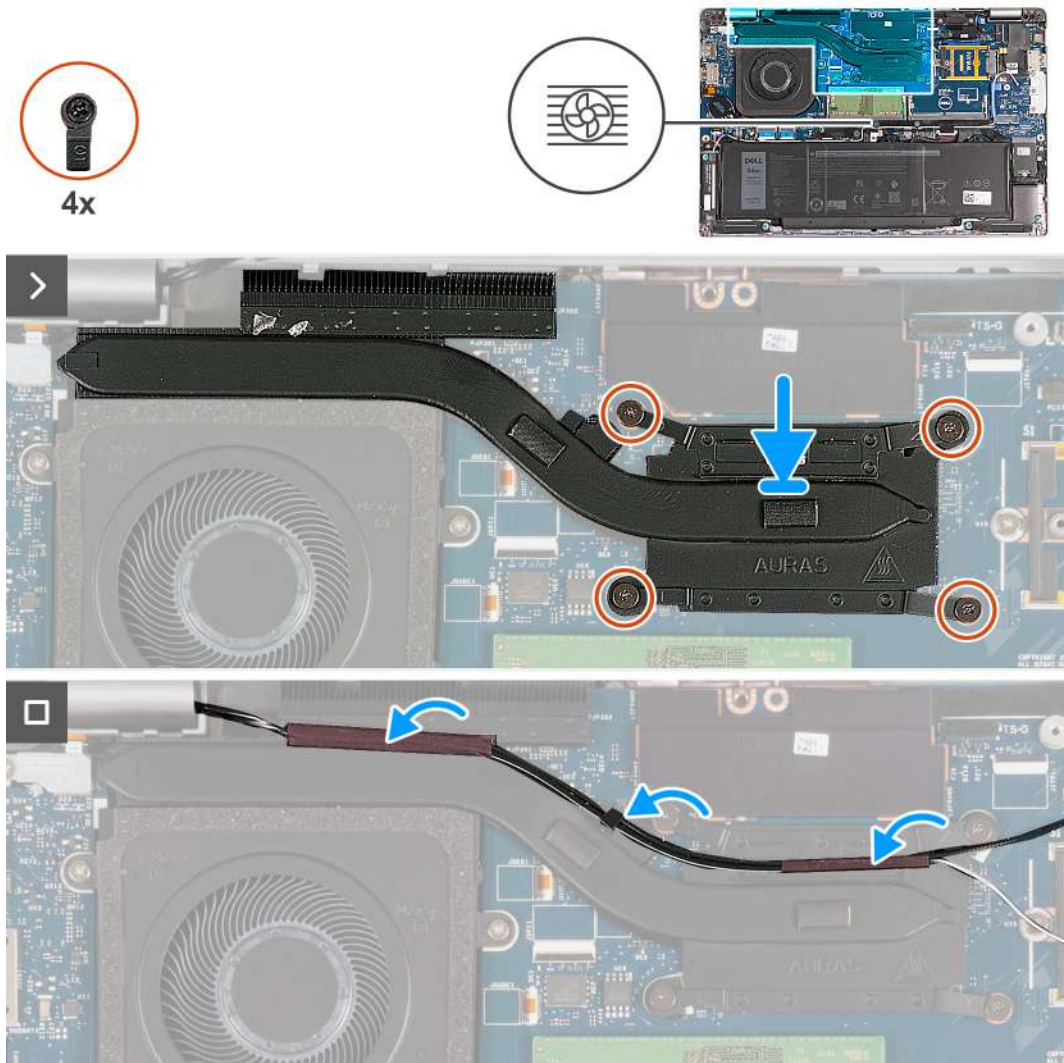
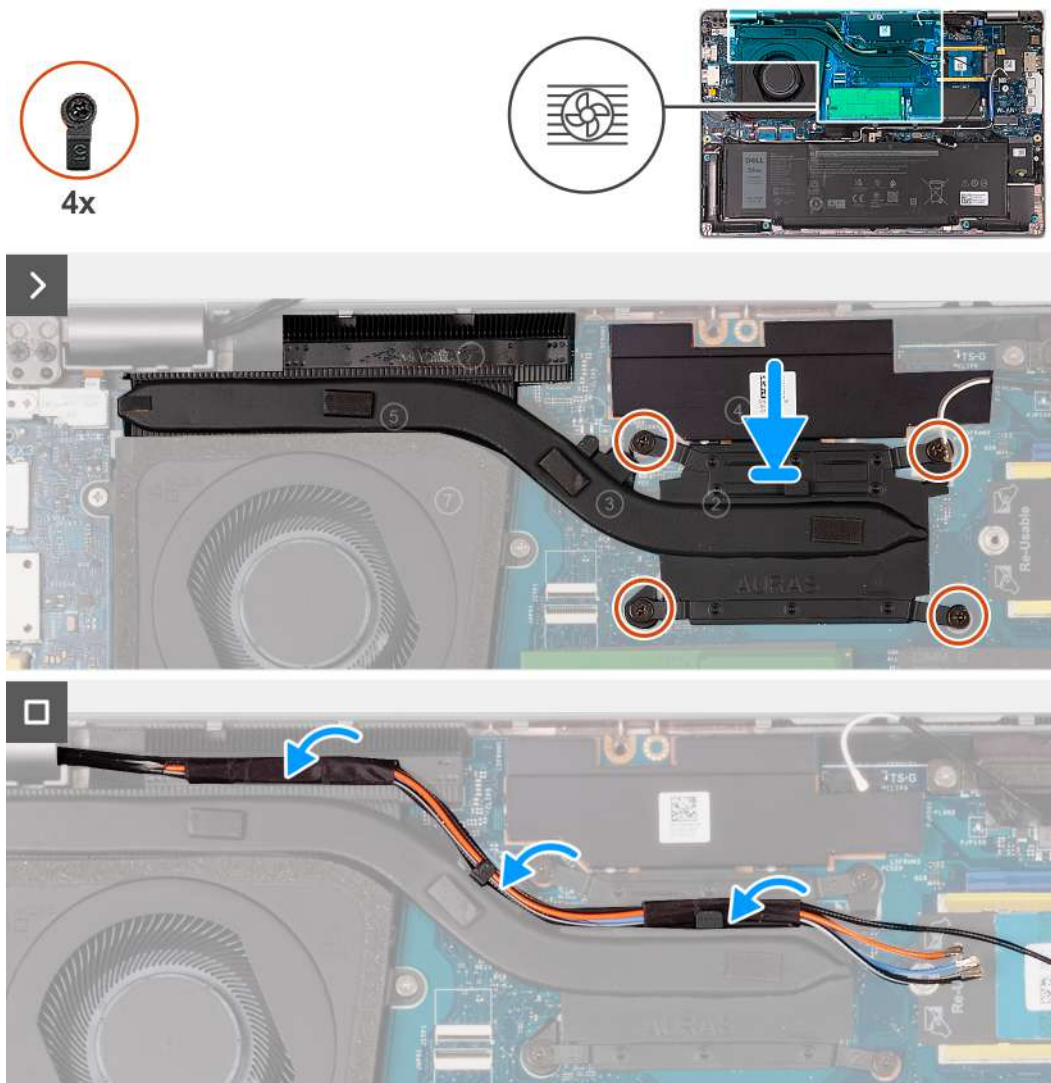

Figure 25. Installing the heat sink - For computers shipped with 4G card



**Figure 26. Installing the heat sink - For computers shipped with 5G card**

### Steps

1. Align and place the heat sink on the system board.
2. Tighten the four captive screws in the sequential order mentioned on the heat sink [1 > 2 > 3 > 4].

**NOTE:** The number of screws varies depending on the configuration ordered.

3. Route the antenna cables through the routing guides on the heat sink.

### Next steps

1. Install the [WWAN card](#).
2. Install the [base cover](#).
3. Install the [nanoSIM card](#).
4. Follow the procedure in [After working inside your computer](#).

## Removing the heat sink - for computers shipped with discrete graphics card

**CAUTION:** The information in this section is intended for authorized service technicians only.

## Prerequisites

1. Follow the procedure in [Before working inside your computer](#).
2. Remove the [nanoSIM card](#).
3. Remove the [base cover](#).
4. Remove the [WWAN card](#).

## About this task

- NOTE:** The heat sink may become hot during normal operation. Allow sufficient time for the heat sink to cool before you touch it.
- NOTE:** For maximum cooling of the processor, do not touch the heat transfer areas on the heat sink. The oils in your skin can reduce the heat transfer capability of the thermal grease.

The following images indicate the location of the heat sink and provide a visual representation of the removal procedure.

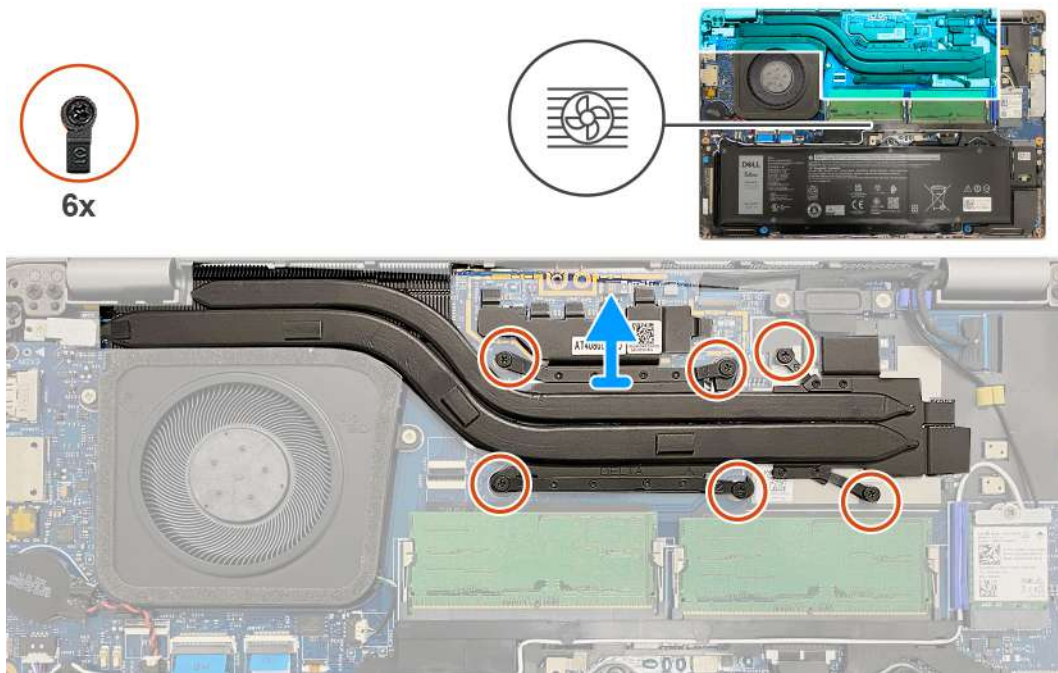

**Figure 27. Removing the heat sink**

## Steps

1. Loosen the six captive screws in the reverse sequential order mentioned on the heat sink [6 > 5 > 4 > 3 > 2 > 1].

**NOTE:** The number of screws varies depending on the configuration ordered.

2. Lift the heat sink from the system board.

## Installing the heat sink - for computers shipped with discrete graphics card

**CAUTION:** The information in this section is intended for authorized service technicians only.

## Prerequisites

If you are replacing a component, remove the existing component before performing the installation process.

### About this task

**NOTE:** If either the system board or the heat sink is replaced, use the thermal grease provided in the kit to ensure that thermal conductivity is achieved.

The following images indicate the location of the heat sink and provide a visual representation of the installation procedure.

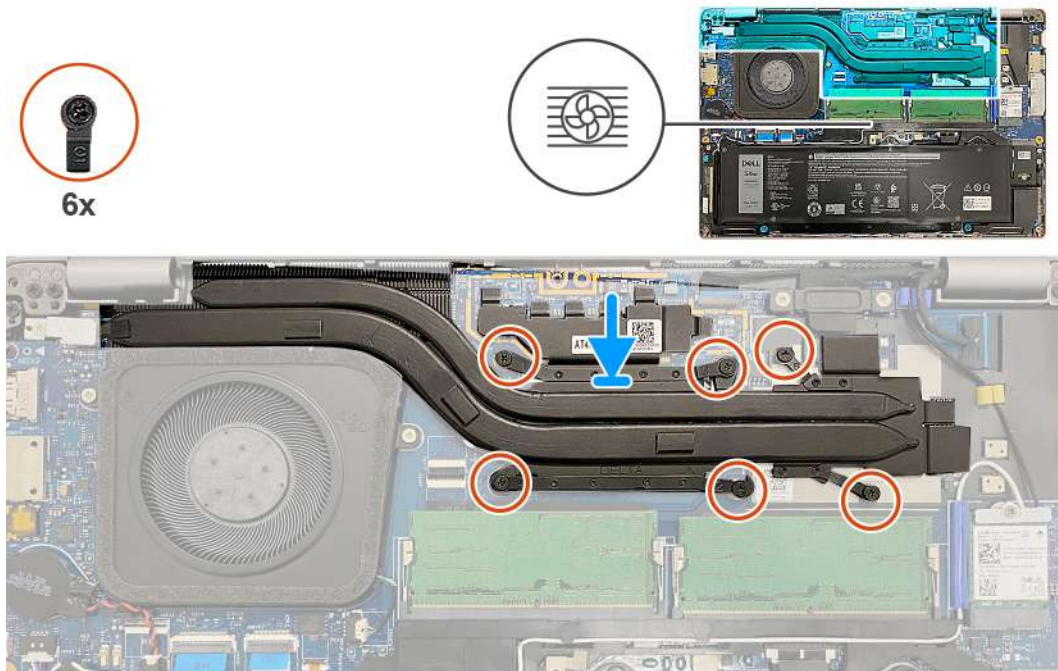

**Figure 28. Installing the heat sink**

### Steps

1. Align and place the heat sink on the system board.
2. Tighten the six captive screws in the sequential order mentioned on the heat sink [1 > 2 > 3 > 4 > 5 > 6].

**NOTE:** The number of screws varies depending on the configuration ordered.

### Next steps

1. Install the [WWAN card](#).
2. Install the [base cover](#).
3. Install the [nanoSIM card](#).
4. Follow the procedure in [After working inside your computer](#).

## Speakers

### Removing the speakers

**CAUTION:** The information in this section is intended for authorized service technicians only.

### Prerequisites

1. Follow the procedure in [Before working inside your computer](#).
2. Remove the [nanoSIM card](#).
3. Remove the [base cover](#).
4. Remove the [wireless card](#).

### About this task

The following images indicate the location of the speakers and provide a visual representation of the removal procedure.

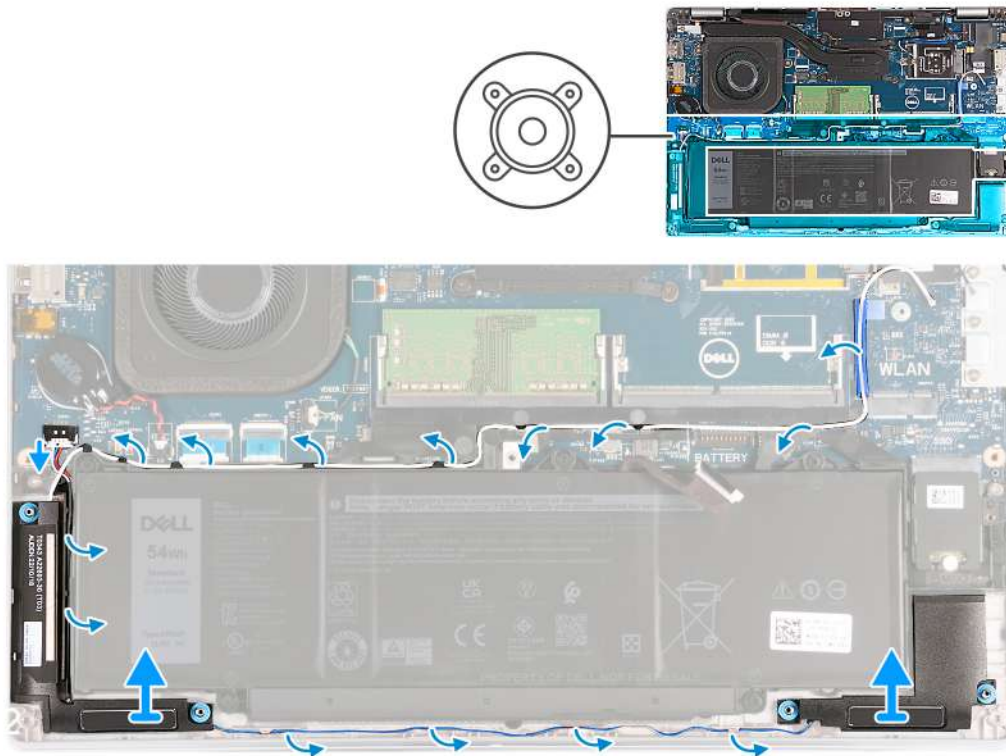

Figure 29. Removing the speakers

### Steps

1. Disconnect the speaker cable from the system board.
2. Remove the white antenna cable and speaker cable from the routing guides on the palm-rest assembly and the assembly inner frame.
3. Lift the right and left speakers, along with its cable, off the palm-rest assembly.

## Installing the speakers

**CAUTION:** The information in this section is intended for authorized service technicians only.

### Prerequisites

If you are replacing a component, remove the existing component before performing the installation process.

### About this task

The following images indicate the location of the speakers and provide a visual representation of the installation procedure.



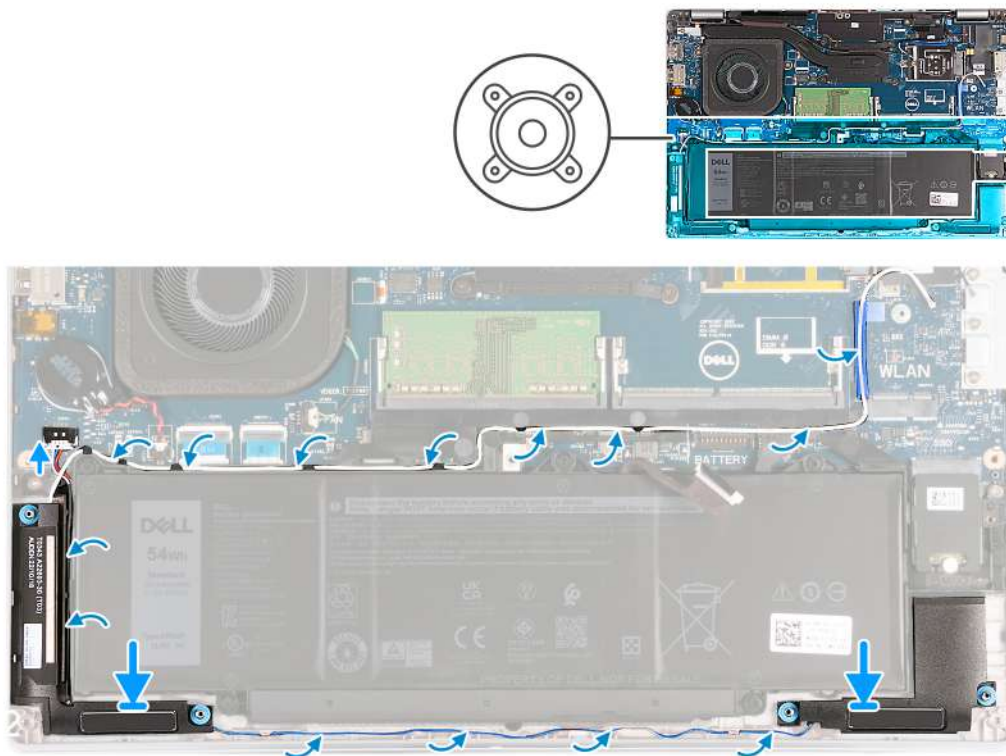

**Figure 30. Installing the speakers**

### Steps

1. Using the alignment posts, place the left and right speakers into their slots on the palm-rest assembly.
2. Route the speaker cable and white antenna cable through the routing guides on the palm-rest assembly.
  - i NOTE:** The wireless card main antenna is bundled with the speakers as a module. When installing the module, first route the speaker cable along the bottom side of the palm-rest assembly, into the routing guide on the left side of the assembly inner frame, and underneath the white wireless main antenna cable. Route the white wireless main antenna cable in the cut-out and along the top side of the assembly inner frame.
3. Connect the speaker cable to the system board.

### Next steps

1. Install the [wireless card](#).
2. Install the [base cover](#).
3. Install the [nanoSIM card](#).
4. Follow the procedure in [After working inside your computer](#).

## Assembly inner frame

### Removing the assembly inner frame

**⚠ CAUTION:** The information in this section is intended for authorized service technicians only.

#### Prerequisites

1. Follow the procedure in [Before working inside your computer](#).
2. Remove the [nanoSIM card](#).
3. Remove the [base cover](#).

4. Remove the [battery](#).
5. Remove the [wireless card](#).
6. Remove the [M.2 2230 solid-state drive](#).

**About this task**

The following images indicate the location of the assembly inner frame and provide a visual representation of the removal procedure.

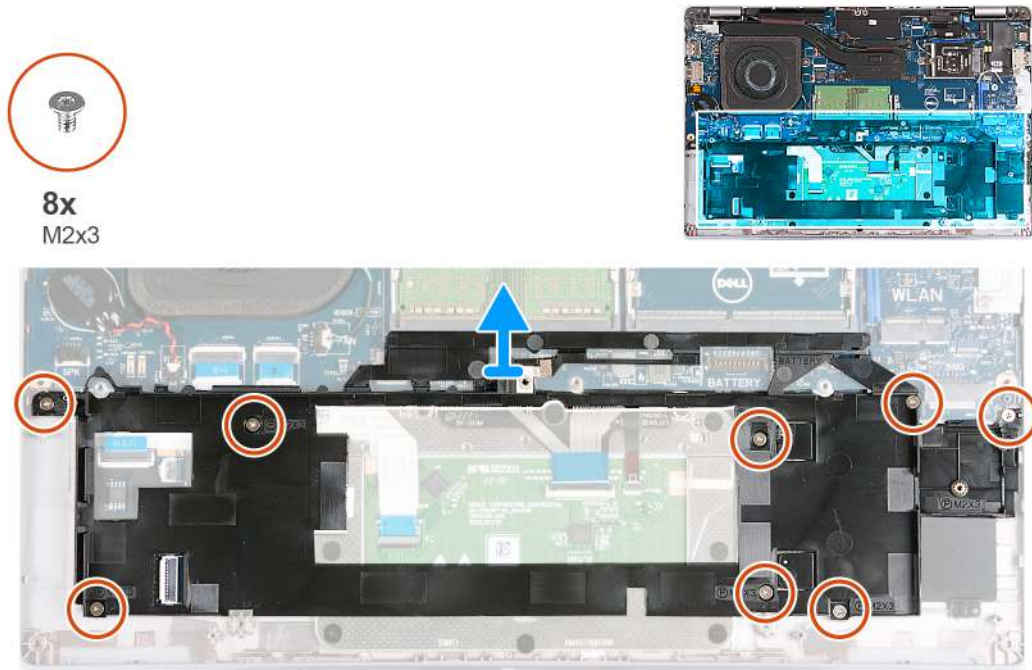

**Figure 31. Removing the assembly inner frame**

**Steps**

1. Remove the antenna cables from the routing guides on the palm-rest assembly.
2. Disconnect the speaker cable from the system board and remove from the routing guides on the assembly inner frame.
3. Remove the eight screws (M2x3) that secure the assembly inner frame to the palm-rest assembly.
4. Remove the assembly inner frame off the palm-rest assembly.

## Installing the assembly inner frame

**CAUTION:** The information in this section is intended for authorized service technicians only.

**Prerequisites**

If you are replacing a component, remove the existing component before performing the installation process.

**About this task**

The following images indicate the location of the assembly inner frame and provide a visual representation of the installation procedure.

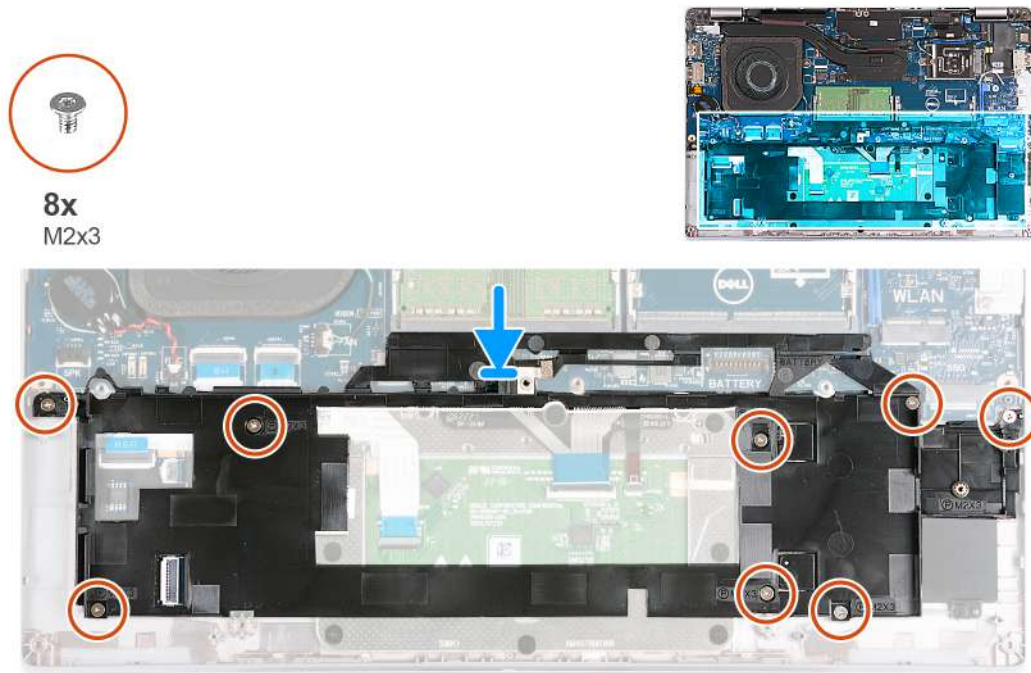

**Figure 32. Installing the assembly inner frame**

#### Steps

1. Using the alignment posts, place the assembly inner frame on the palm-rest assembly.
2. Align the screw holes on the assembly inner frame with the screw holes on the system board and the palm-rest assembly.
3. Replace the eight screws (M2x3) that secures the assembly inner frame to palm-rest assembly.
4. Connect the speaker cable to the system board and route the speaker cables through the routing guides on the assembly inner frame.
5. Route the antenna cables through the routing guides on the palm-rest assembly.

#### Next steps

1. Install the [2230 solid-state drive](#).
2. Install the [wireless card](#).
3. Install the [battery](#).
4. Install the [base cover](#).
5. Install the [nanoSIM card](#).
6. Follow the procedure in [After working inside your computer](#).

## Display assembly

### Removing the display assembly

**CAUTION:** The information in this section is intended for authorized service technicians only.

#### Prerequisites

1. Follow the procedure in [Before working inside your computer](#).
2. Remove the [nanoSIM card](#).
3. Remove the [base cover](#).
4. Remove the [wireless card](#).
5. Remove the [WWAN card](#).

**About this task**

The following images indicate the location of the display assembly and provide a visual representation of the removal procedure.

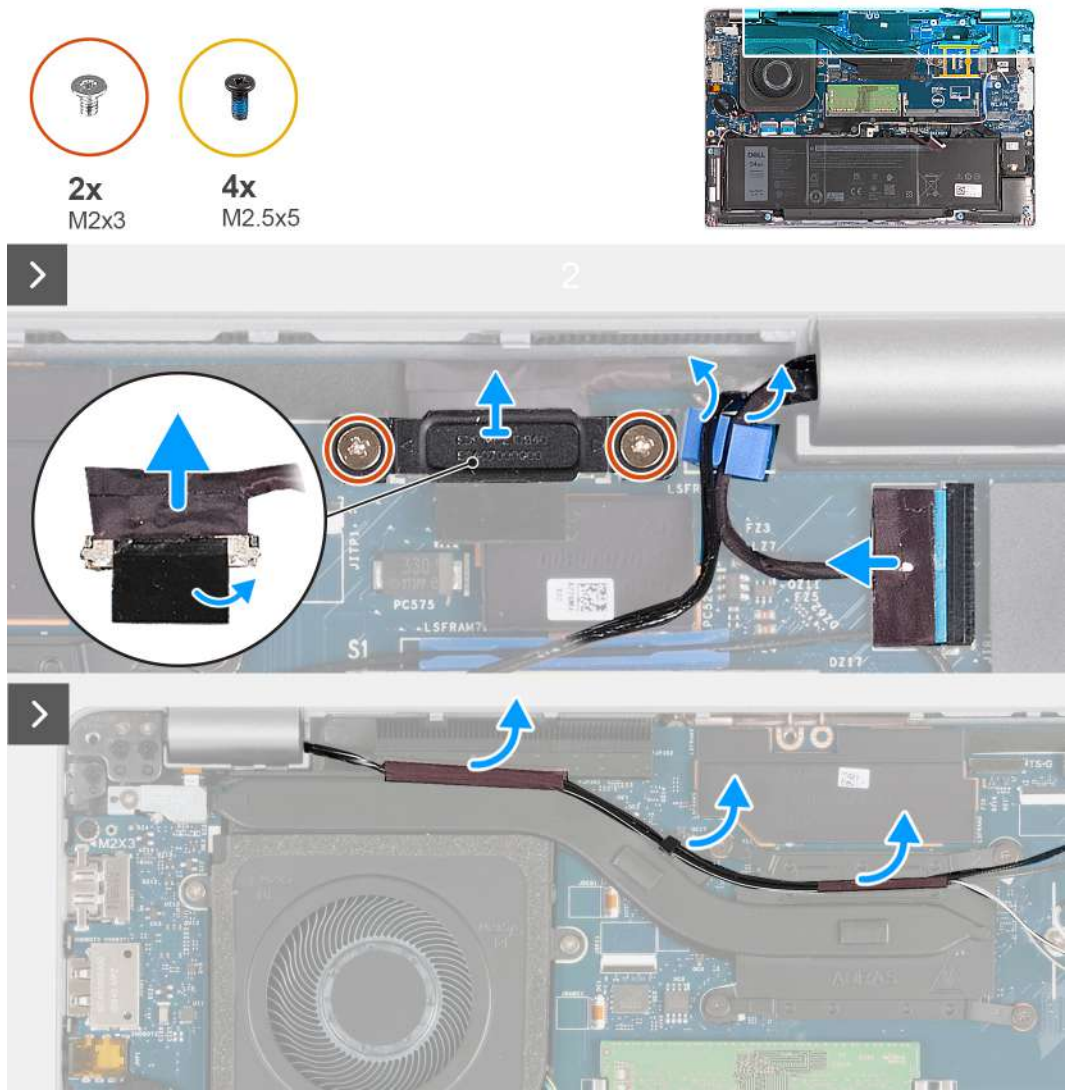

**Figure 33. Removing the display assembly - For computers shipped with 4G card**



Figure 34. Removing the display assembly - For computers shipped with 4G card

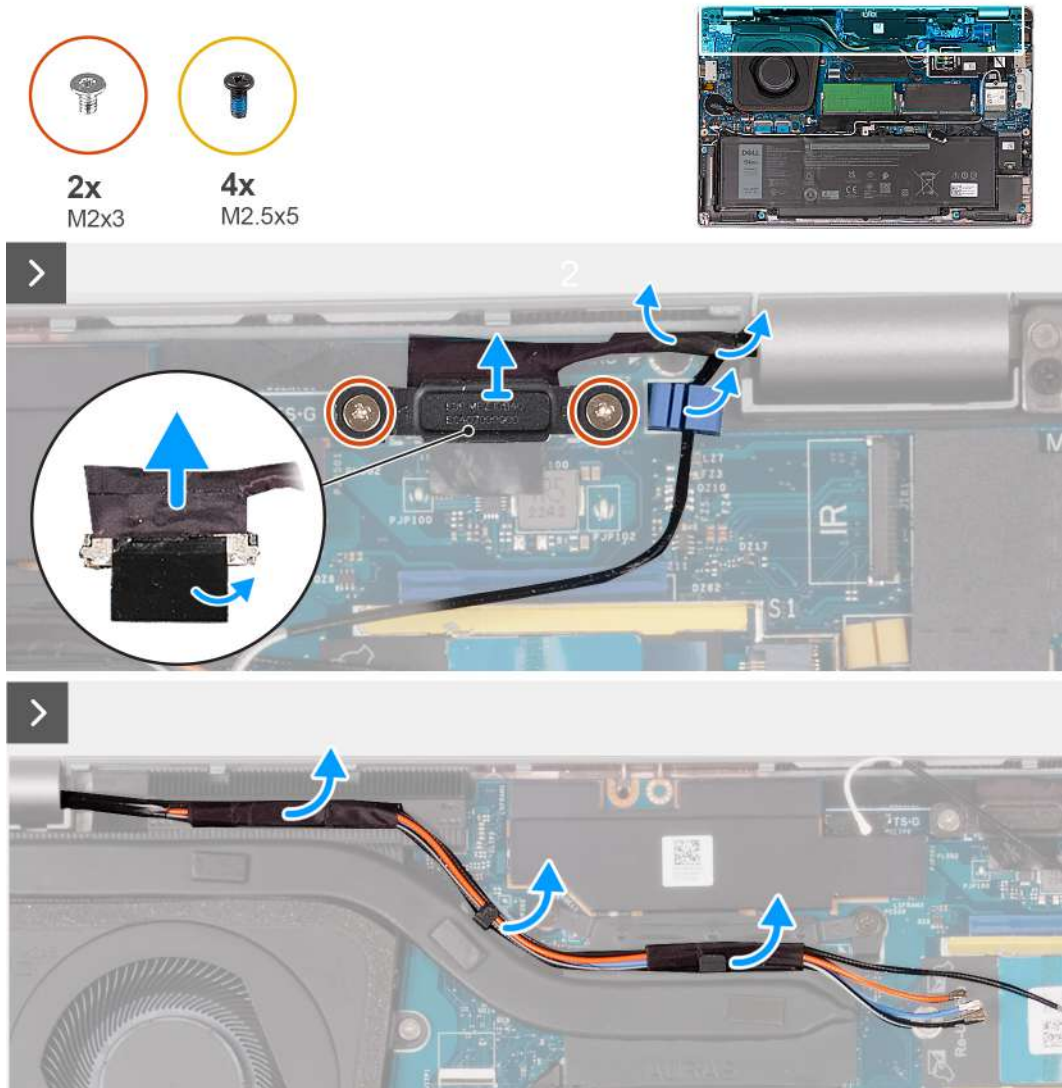

Figure 35. Removing the display assembly - For computers shipped with 5G card



**Figure 36. Removing the display assembly - For computers shipped with 5G card**

### Steps

1. Remove the antenna cables from the routing guides on the heat sink.
2. Remove the two (M2x3) screws that secure the display cable bracket to the system board.
3. Lift the display cable bracket away from the computer.
4. Peel the tape that secures the display cable to the system board.
5. Disconnect the display cable from the system board.
6. Disconnect the touchscreen cable from the system board (optional).
7. Disconnect the G-Sensor board cable from the system board (optional).
8. Disconnect the IR camera cable from the system board and remove the cable from the routing guide on the palm-rest assembly (optional).
9. Turn the computer over and open the display at an angle of 90 degrees.
10. Rotate the computer and place it in a position that allows access to the screws on the display.
11. Remove the four screws (M2.5x5) that secure the left and right display hinges to the palm-rest assembly.
12. Carefully lift the display assembly from the palm-rest assembly.
13. Carefully place the display assembly on a clean, flat surface.

## Installing the display assembly

**⚠ CAUTION:** The information in this section is intended for authorized service technicians only.

### Prerequisites

If you are replacing a component, remove the existing component before performing the installation process.

### About this task

The following images indicate the location of the display assembly and provide a visual representation of the installation procedure.

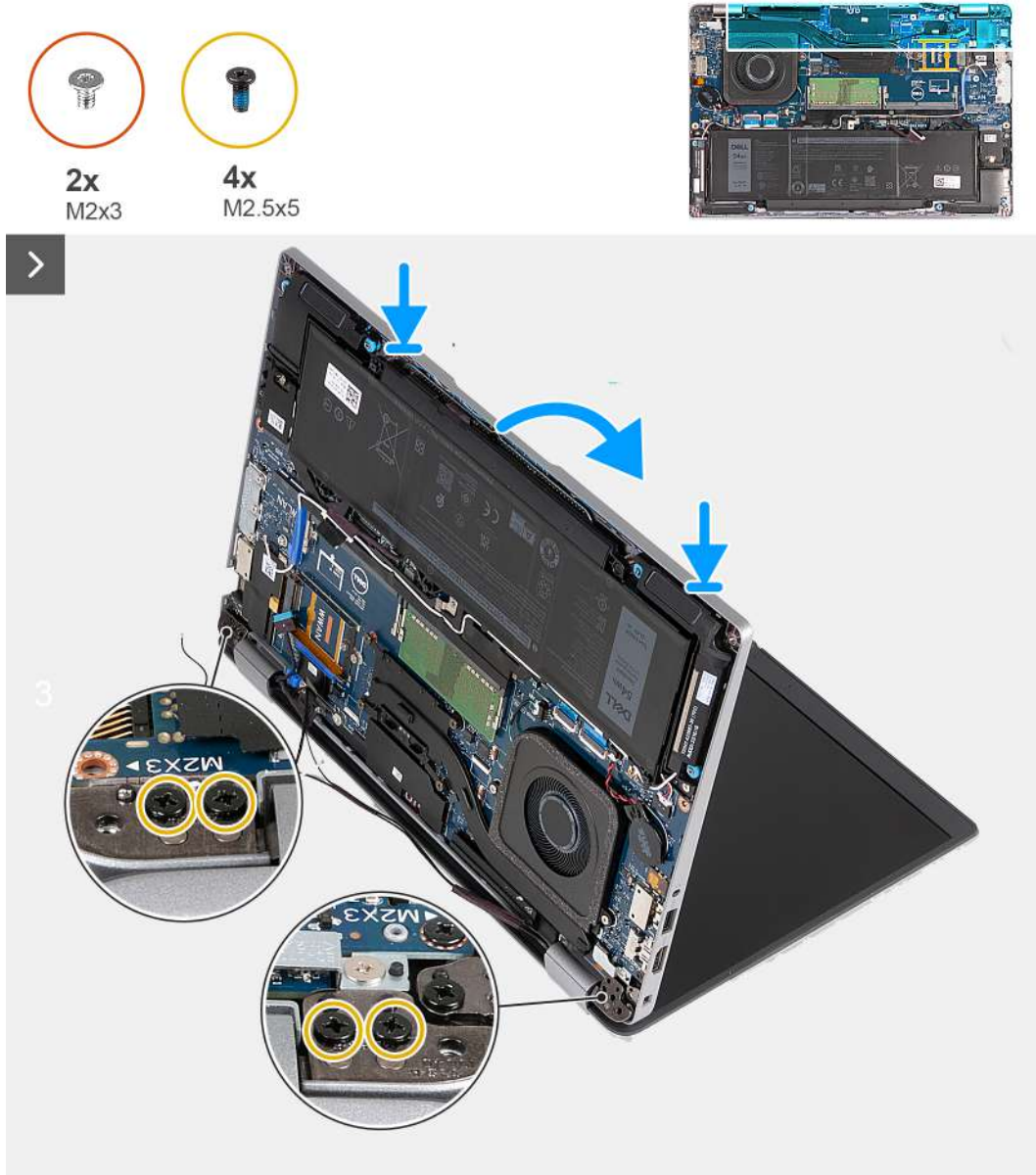

Figure 37. Installing the display assembly - For computers shipped with 4G card



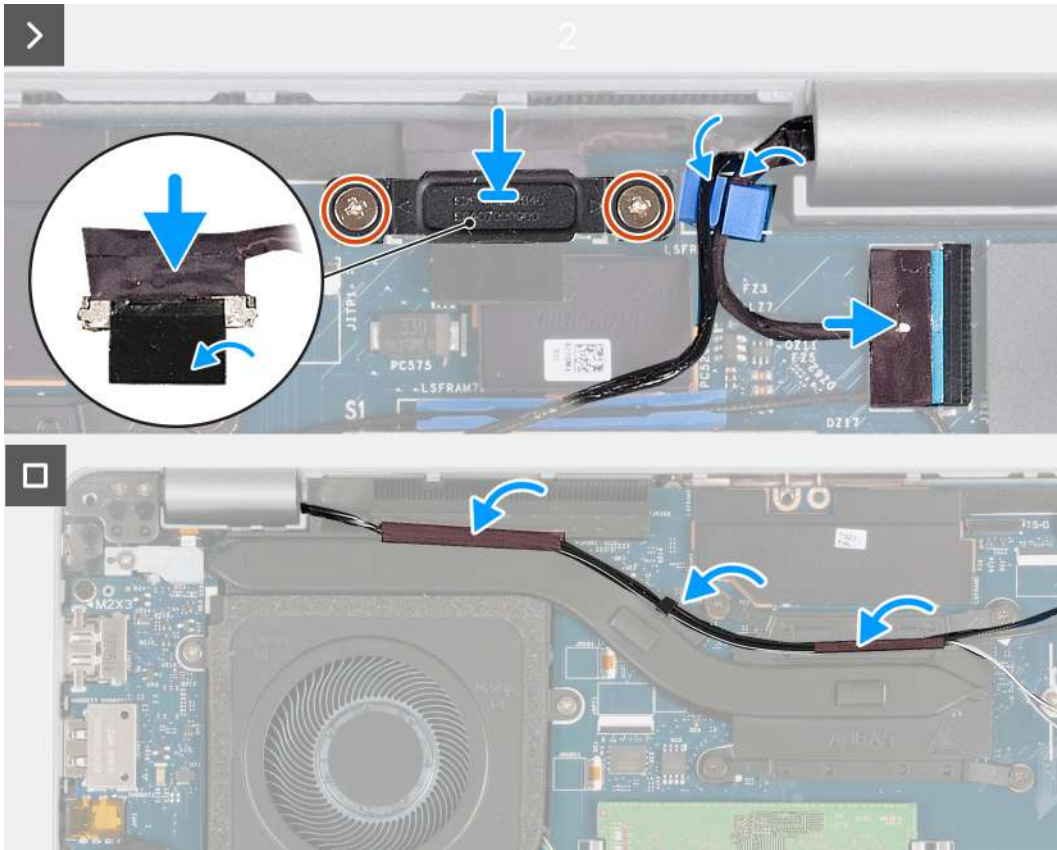

Figure 38. Installing the display assembly - For computers shipped with 4G card

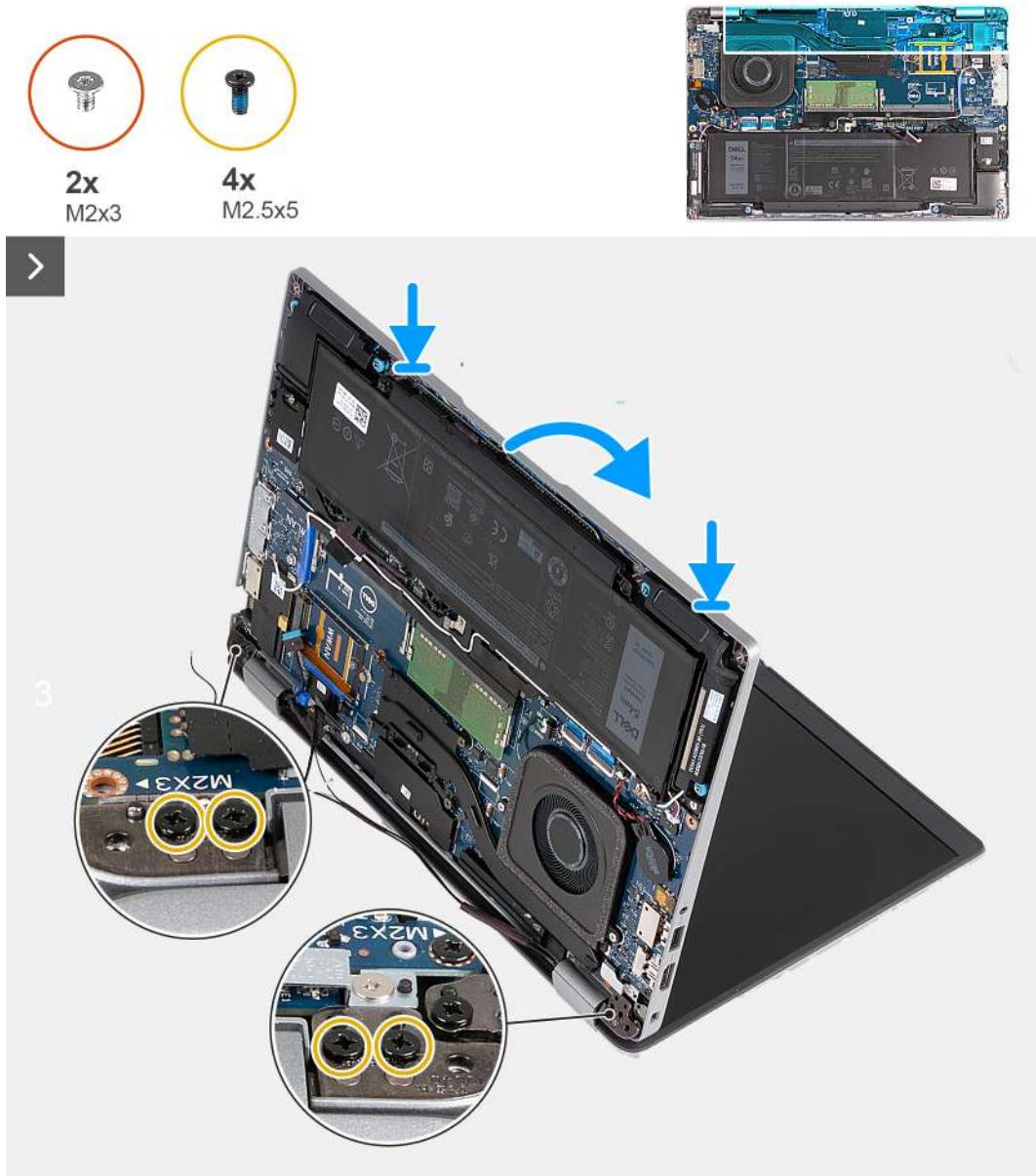
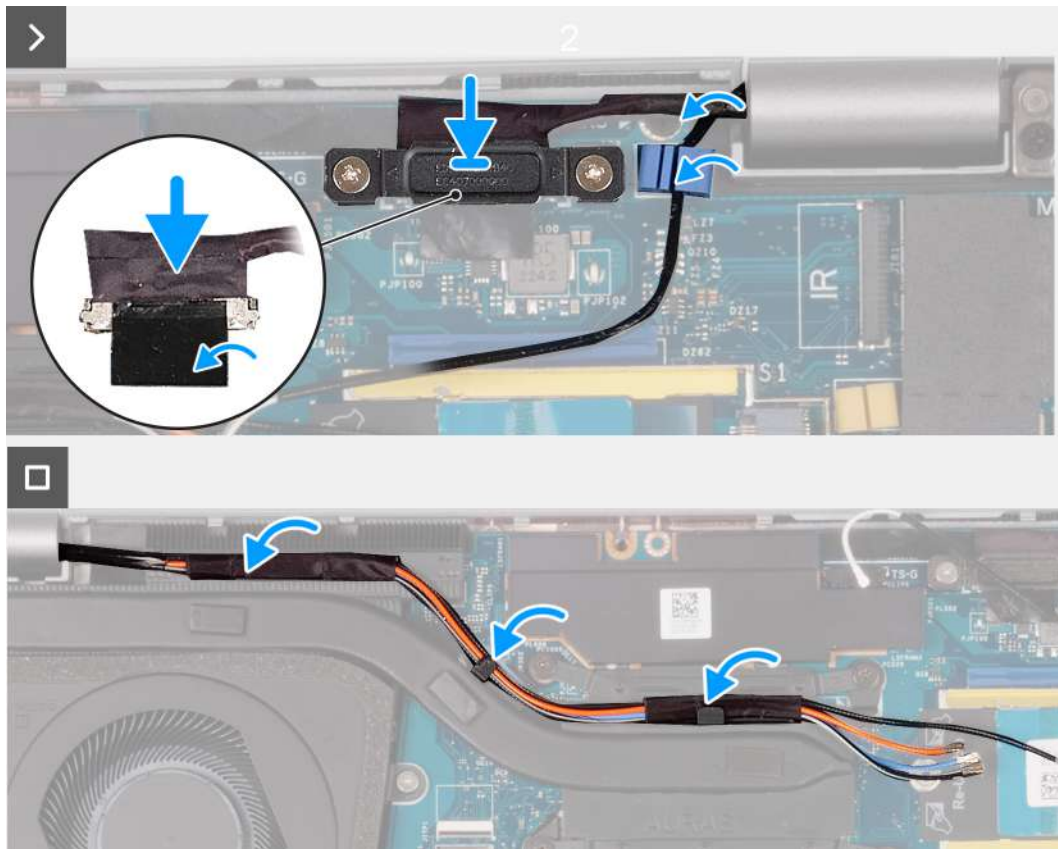

Figure 39. Installing the display assembly - For computers shipped with 5G card



**Figure 40. Installing the display assembly - For computers shipped with 5G card**

### Steps

1. Align the screw holes on the palm-rest assembly with the screw holes on the display hinges.
2. Replace the four screws (M2.5x5) that secure the left and right display hinges to the palm-rest assembly.
3. Turn the computer over and open the display at an angle of 90 degrees.
4. Close the display and turn the computer over.
5. Connect the IR camera cable to the connector on the system board and route the IR camera cable through the routing guide on the palm-rest assembly (optional).
6. Connect the G-Sensor board cable to the system board (optional).
7. Connect the touchscreen cable to the system board (optional).
8. Connect the display cable to the system board.
9. Adhere the tape that secures the display cable to the system board.
10. Align the screw holes on the display cable bracket with the screw holes on the system board.
11. Replace the two (M2x3) screws that secure the display cable bracket to the system board.
12. Route the antenna cables on the routing guides on the heat sink.

### Next steps

1. Install the [WWAN card](#).
2. Install the [wireless card](#).
3. Install the [base cover](#).
4. Install the [nanoSIM card](#).
5. Follow the procedure in [After working inside your computer](#).

# Display bezel

## Removing the display bezel

**CAUTION:** The information in this section is intended for authorized service technicians only.

### Prerequisites

1. Follow the procedure in [Before working inside your computer](#).
2. Remove the [nanoSIM card](#).
3. Remove the [base cover](#).
4. Remove the [wireless card](#).
5. Remove the [WWAN card](#).
6. Remove the [display assembly](#).

### About this task

The following images indicate the location of the display bezel and provide a visual representation of the removal procedure.

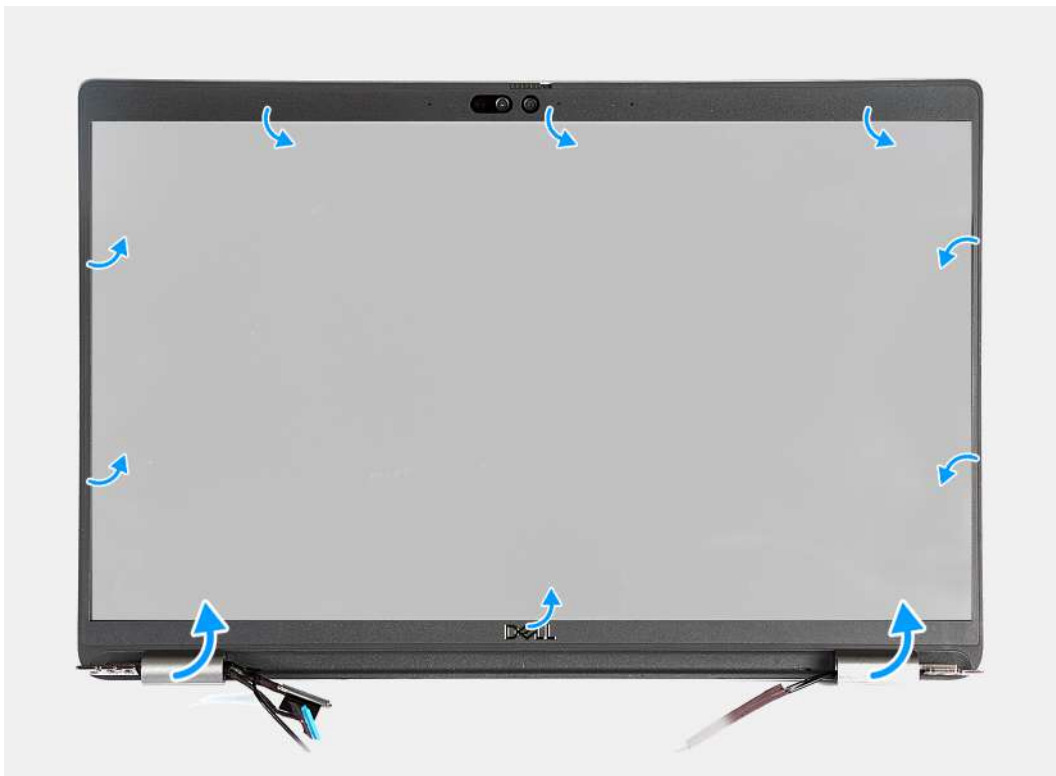

**Figure 41. Removing the display bezel**

### Steps

1. Carefully pry up the display bezel starting from the recesses on the bottom edge of the display near the left and right hinges.
2. Pry along the outside edge of the display bezel and work your way around the entire display bezel until the display bezel is separated from the display cover.
3. Lift the display bezel from the display assembly.

## Installing the display bezel

**CAUTION:** The information in this section is intended for authorized service technicians only.

## Prerequisites

If you are replacing a component, remove the existing component before performing the installation process.

## About this task

The following images indicate the location of the display bezel and provide a visual representation of the installation procedure.

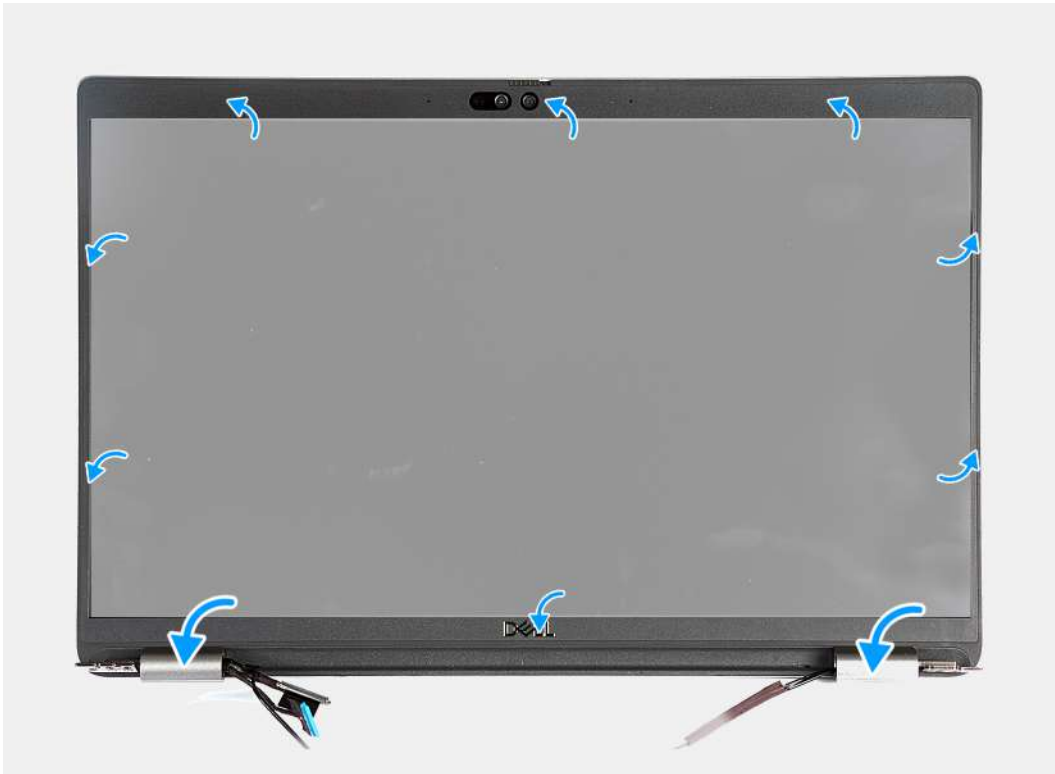

**Figure 42. Installing the display bezel**

## Steps

1. Align and place the display bezel on the display assembly.
2. Gently snap the display bezel into place.

## Next steps

1. Install the [display assembly](#).
2. Install the [WWAN card](#).
3. Install the [wireless card](#).
4. Install the [base cover](#).
5. Install the [nanoSIM card](#).
6. Follow the procedure in [After working inside your computer](#).

# Display panel

## Removing the display panel

**CAUTION:** The information in this section is intended for authorized service technicians only.

## Prerequisites

1. Follow the procedure in [Before working inside your computer](#).
2. Remove the [nanoSIM card](#).

3. Remove the [base cover](#).
4. Remove the [wireless card](#).
5. Remove the [WWAN card](#).
6. Remove the [display assembly](#).
7. Remove the [display bezel](#).

**About this task**

The following images indicate the location of the display panel and provide a visual representation of the removal procedure.

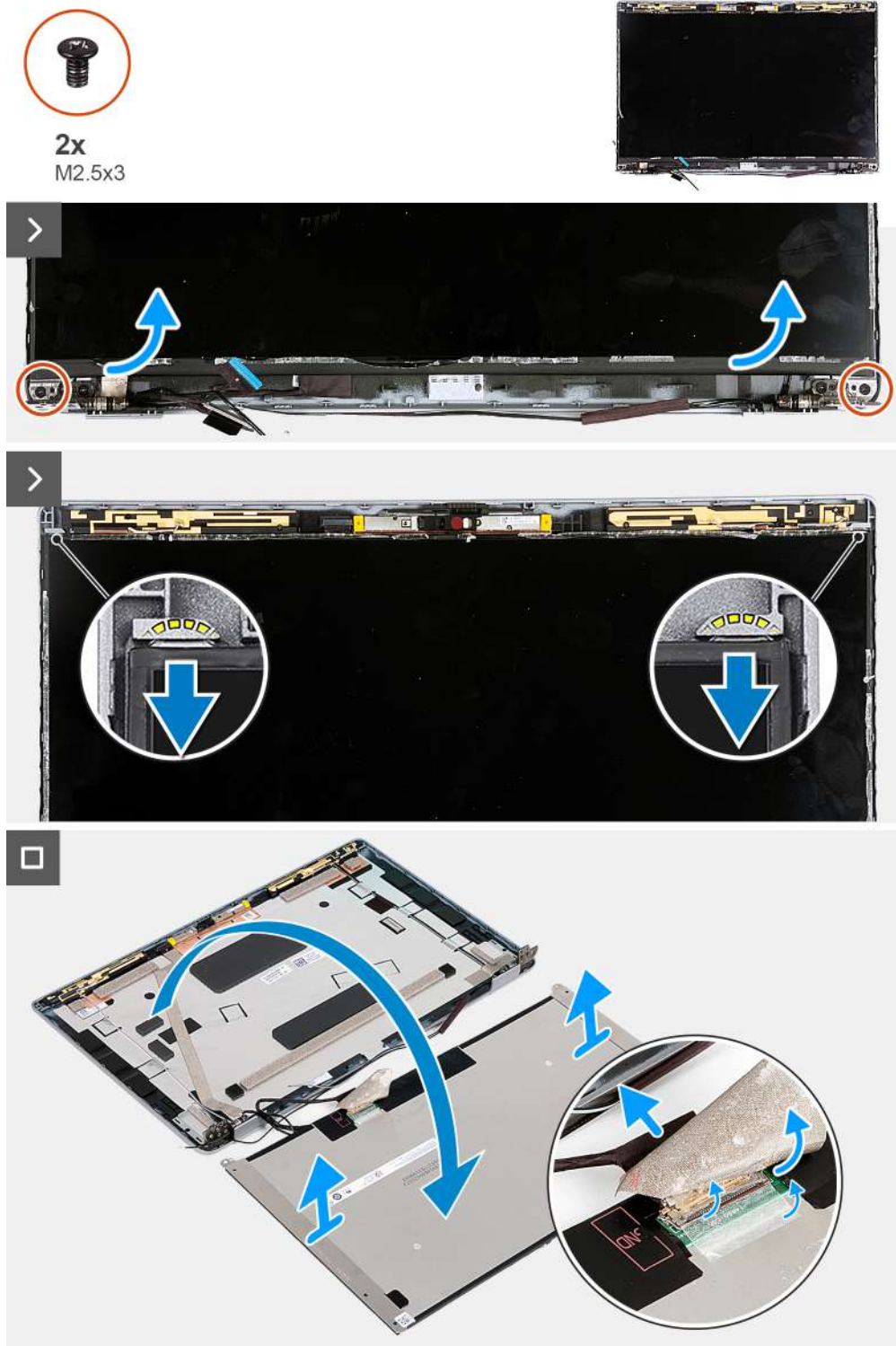

**Figure 43. Removing the display panel**

 **NOTE:** The display panel is preassembled with the display brackets as a single service part. Do not pull the Stretch Release (SR) tapes and separate the brackets from the display panel.

### Steps

1. Remove the two screws (M2.5x3) that secure the display panel to the display back cover.
2. Lift the bottom edge of the display panel, slide the display panel downwards to release the display bracket from the slots at the top side of the display back cover.
3. Peel the tape that secures the display cable to the display panel.
4. Open the latch and disconnect the display cable from the connector on the display panel.
5. Lift the display panel away from the display back cover.

## Installing the display panel

 **CAUTION:** The information in this section is intended for authorized service technicians only.

### Prerequisites

If you are replacing a component, remove the existing component before performing the installation process.

### About this task

The following images indicate the location of the display panel and provide a visual representation of the installation procedure.

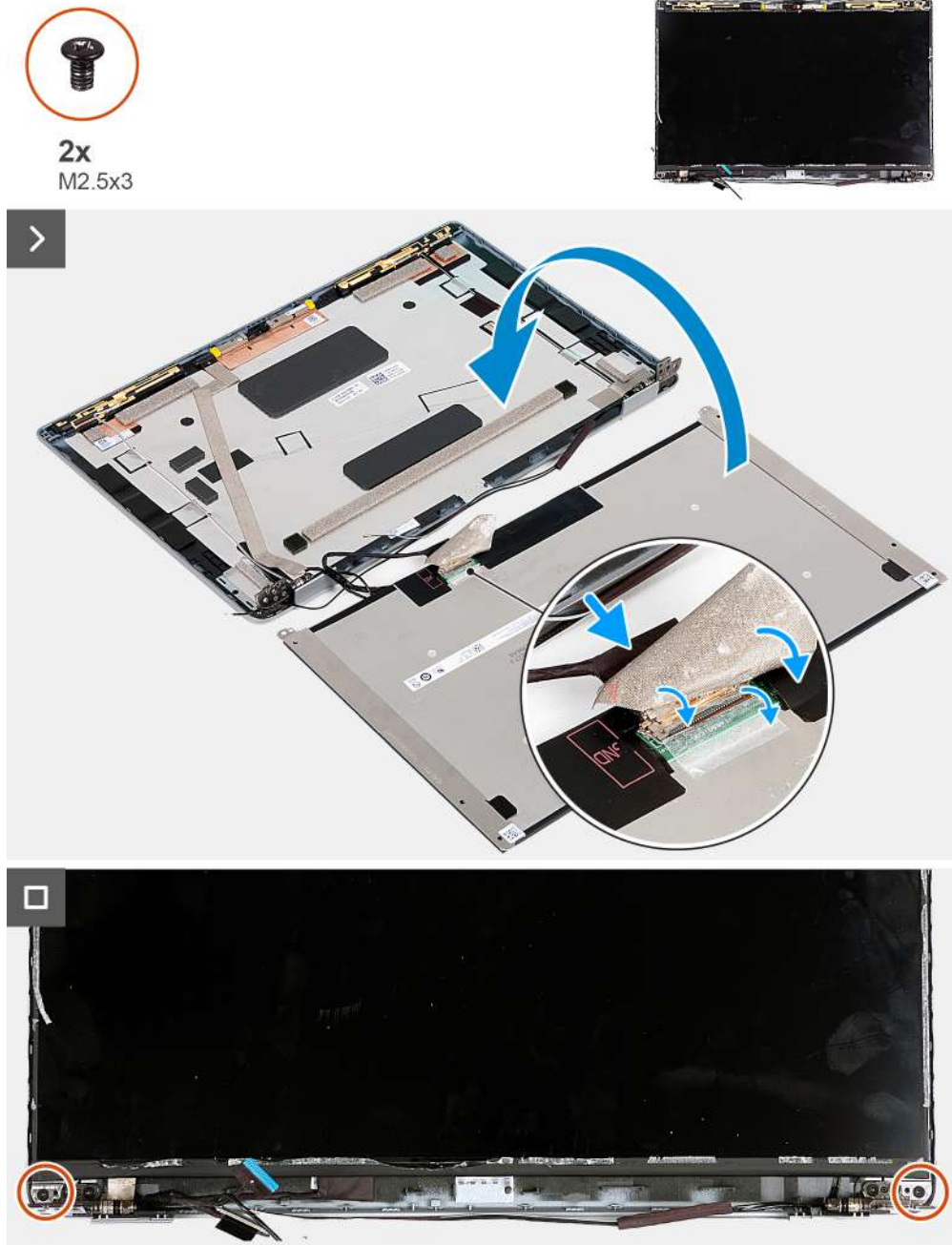

**Figure 44. Installing the display panel**

**Steps**

1. Connect the display cable to the connector on the display panel and close the latch to secure the cable.
2. Adhere the tape that secures the display cable to the display panel.
3. Close the display panel and the display back cover to assemble.

**i** **NOTE:** Ensure that the display panel tabs are inserted into the slots on the display cover.

4. Replace the two screws (M2.5x3) to secure the display panel to the display back cover.

**Next steps**

1. Install the [display bezel](#).
2. Install the [display assembly](#).
3. Install the [WWAN card](#).



4. Install the [wireless card](#).
5. Install the [base cover](#).
6. Install the [nanoSIM card](#).
7. Follow the procedure in [After working inside your computer](#).

## Camera module

### Removing the camera module

**CAUTION:** The information in this section is intended for authorized service technicians only.

#### Prerequisites

1. Follow the procedure in [Before working inside your computer](#).
2. Remove the [nanoSIM card](#).
3. Remove the [base cover](#).
4. Remove the [wireless card](#).
5. Remove the [WWAN card](#).
6. Remove the [display assembly](#).
7. Remove the [display bezel](#).
8. Remove the [display panel](#).

#### About this task

The following images indicate the location of the camera module and provide a visual representation of the removal procedure.

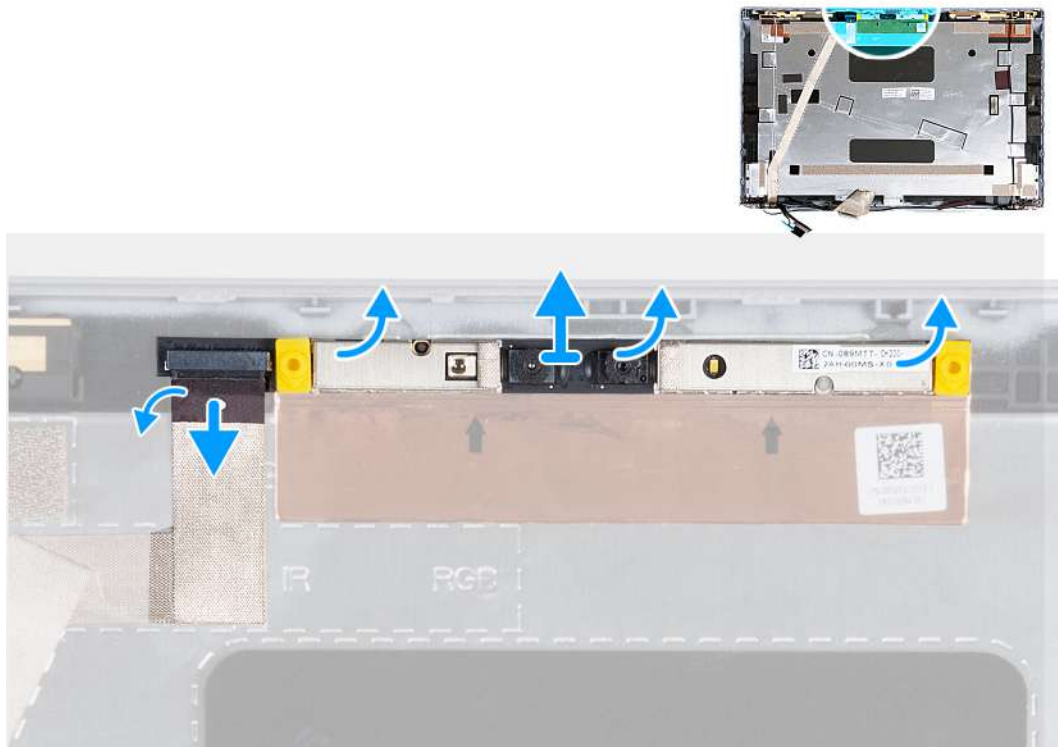

**Figure 45. Removing the camera module**

#### Steps

1. Peel the tape that secures the camera cable to the display back cover.
2. Disconnect the camera cable from the camera.
3. Carefully pry up the camera module from the recesses at the bottom edge of the camera module.

4. Lift the camera module from the display back cover.

## Installing the camera module

**CAUTION:** The information in this section is intended for authorized service technicians only.

### Prerequisites

If you are replacing a component, remove the existing component before performing the installation process.

### About this task

The following images indicate the location of the camera module and provide a visual representation of the installation procedure.

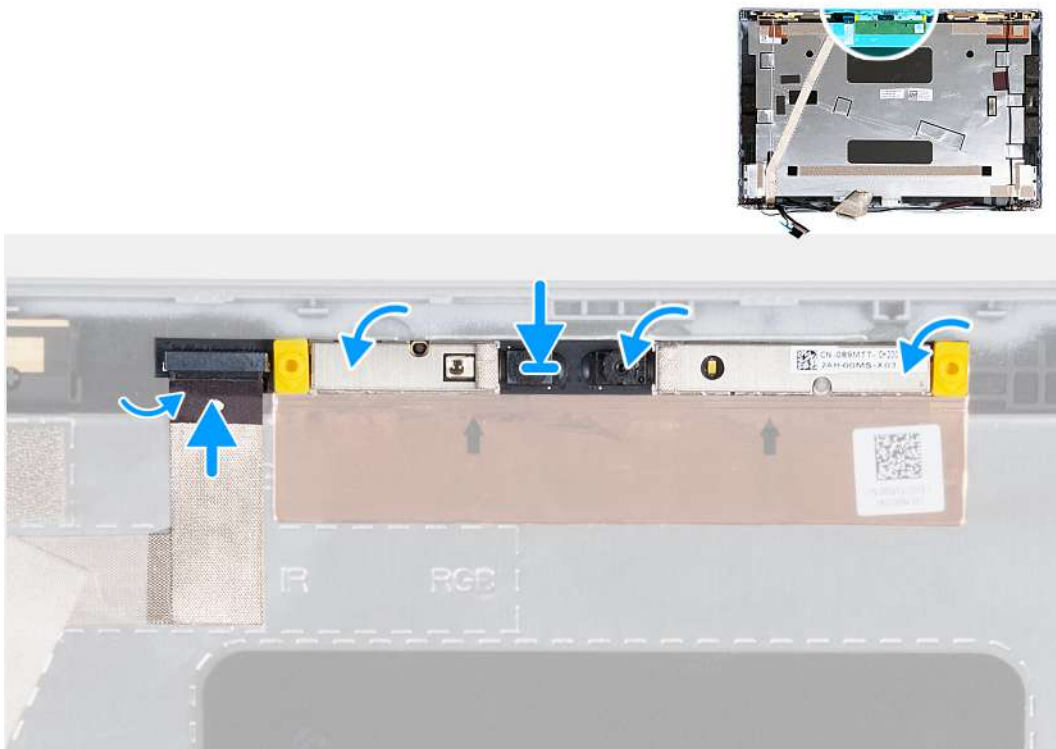

**Figure 46. Installing the camera module**

### Steps

1. Align the camera module with the pins on the display back cover.
2. Connect the camera module cable to the connector on the camera module.
3. Adhere the tape to secure the camera cable to the camera.

### Next steps

1. Install the [display panel](#).
2. Install the [display bezel](#).
3. Install the [display assembly](#).
4. Install the [WWAN card](#).
5. Install the [wireless card](#).
6. Install the [base cover](#).
7. Install the [nanoSIM card](#).
8. Follow the procedure in [After working inside your computer](#).

# Display hinges

## Removing the display hinges

**CAUTION:** The information in this section is intended for authorized service technicians only.

### Prerequisites

1. Follow the procedure in [Before working inside your computer](#).
2. Remove the [nanoSIM card](#).
3. Remove the [base cover](#).
4. Remove the [wireless card](#).
5. Remove the [WWAN card](#).
6. Remove the [display assembly](#).
7. Remove the [display bezel](#).
8. Remove the [display panel](#).

### About this task

The following images indicate the location of the display hinges and provide a visual representation of the removal procedure.

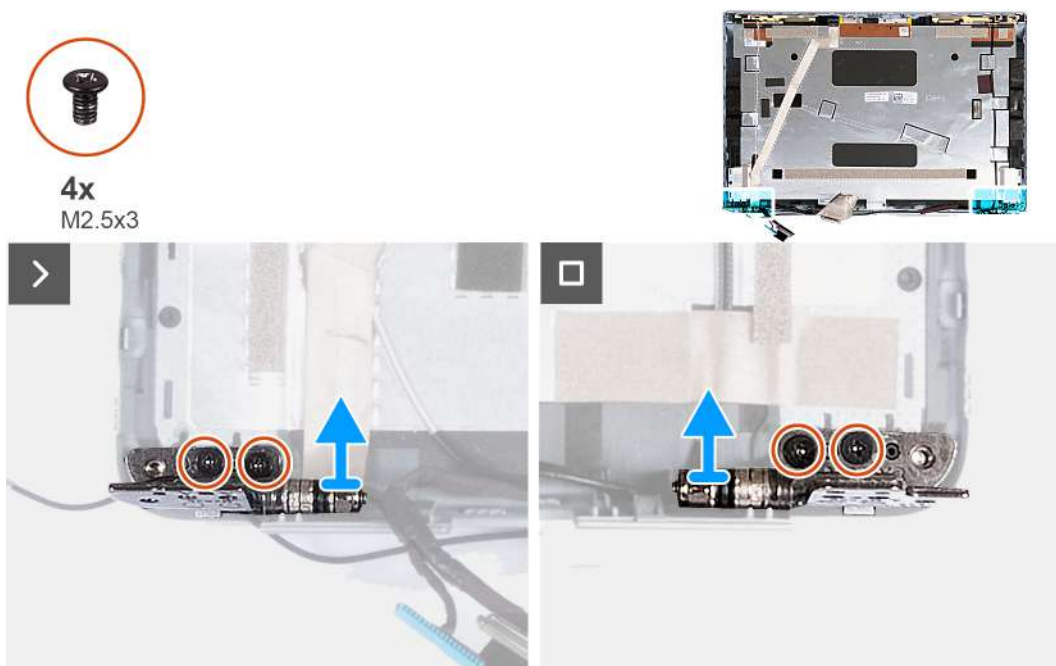

**Figure 47. Removing the display hinges**

### Steps

1. Remove the two (M2.5x3) screws that secure the right hinge to the display back cover.
2. Lift and remove the right hinge from the display back cover.
3. Remove the two (M2.5x3) screws that secure the left hinge to the display back cover.
4. Lift and remove the left hinge from the display back cover.

## Installing the display hinges

**CAUTION:** The information in this section is intended for authorized service technicians only.

## Prerequisites

If you are replacing a component, remove the existing component before performing the installation process.

## About this task

The following images indicate the location of the display hinges and provide a visual representation of the installation procedure.

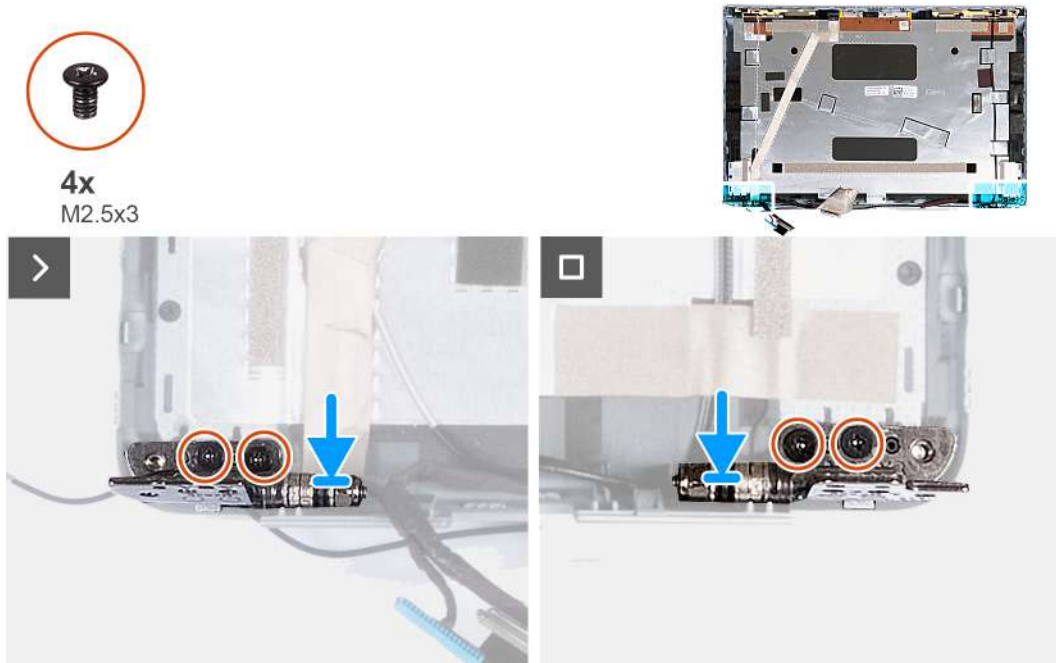

**Figure 48. Installing the display hinges**

## Steps

1. Align the screw hole on the left hinge with the screw hole on the display back cover.
2. Replace the two screws (M2.5x3) to secure the left hinge to the display back cover.
3. Align the screw hole on the right hinge with the screw hole on the display back cover.
4. Replace the two screws (M2.5x3) to secure the right hinge to the display back cover.

## Next steps

1. Install the [display panel](#).
2. Install the [display bezel](#).
3. Install the [display assembly](#).
4. Install the [WWAN card](#).
5. Install the [wireless card](#).
6. Install the [base cover](#).
7. Install the [nanoSIM card](#).
8. Follow the procedure in [After working inside your computer](#).

# Display cable

## Removing the display cable

**CAUTION:** The information in this section is intended for authorized service technicians only.

### Prerequisites

1. Follow the procedure in [Before working inside your computer](#).
2. Remove the [nanoSIM card](#).
3. Remove the [base cover](#).
4. Remove the [wireless card](#).
5. Remove the [WWAN card](#).
6. Remove the [display assembly](#).
7. Remove the [display bezel](#).
8. Remove the [display panel](#).

### About this task

The following images indicate the location of the display cable and provide a visual representation of the removal procedure.

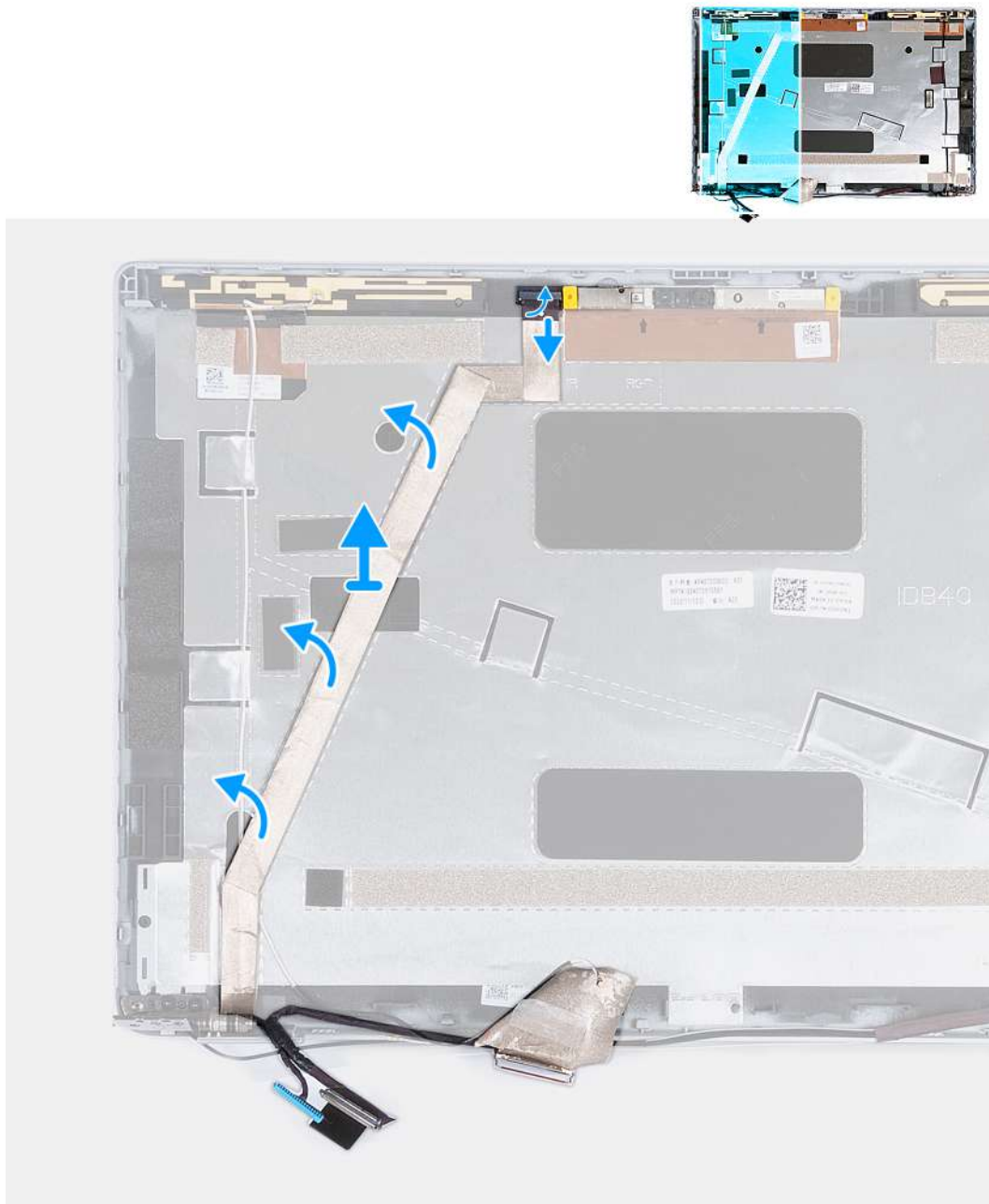

**Figure 49. Removing the display cable**

### Steps

1. Peel the tape that secures the camera cable to the display back cover.
2. Disconnect the camera cable from the camera module.
3. Peel the display cable to release it from adhesive and lift the display cable off the display back cover.

## Installing the display cable

 **CAUTION:** The information in this section is intended for authorized service technicians only.

### Prerequisites

If you are replacing a component, remove the existing component before performing the installation process.

### About this task

The following images indicate the location of the display cable and provide a visual representation of the installation procedure.

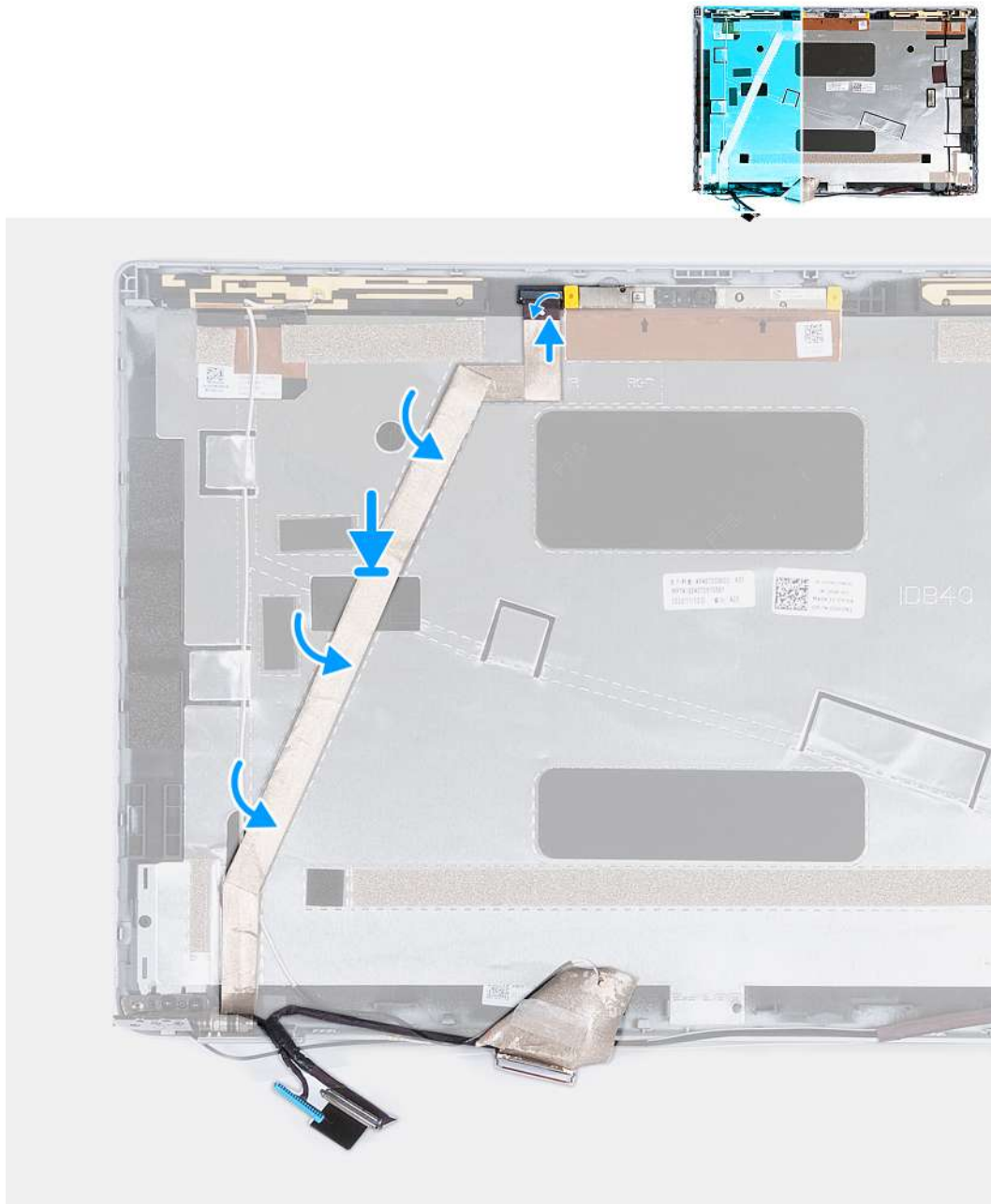

**Figure 50. Installing the display cable**

### Steps

1. Adhere the display cable to the display back cover.
2. Connect the camera cable to the connector on the camera.
3. Adhere the tape that secures the camera cable to the display back cover.

### Next steps

1. Install the [display panel](#).
2. Install the [display bezel](#).
3. Install the [display assembly](#).
4. Install the [WWAN card](#).
5. Install the [wireless card](#).
6. Install the [base cover](#).
7. Install the [nanoSIM card](#).

8. Follow the procedure in [After working inside your computer](#).

## Display back cover

### Removing the display back cover

**CAUTION:** The information in this section is intended for authorized service technicians only.

#### Prerequisites

1. Follow the procedure in [Before working inside your computer](#).
2. Remove the [nanoSIM card](#).
3. Remove the [base cover](#).
4. Remove the [wireless card](#).
5. Remove the [WWAN card](#).
6. Remove the [display assembly](#).
7. Remove the [display bezel](#).
8. Remove the [display panel](#).
9. Remove the [camera module](#).
10. Remove the [display hinges](#).
11. Remove the [display cable](#).

#### About this task

The following images indicate the location of the display back cover and provide a visual representation of the removal procedure.

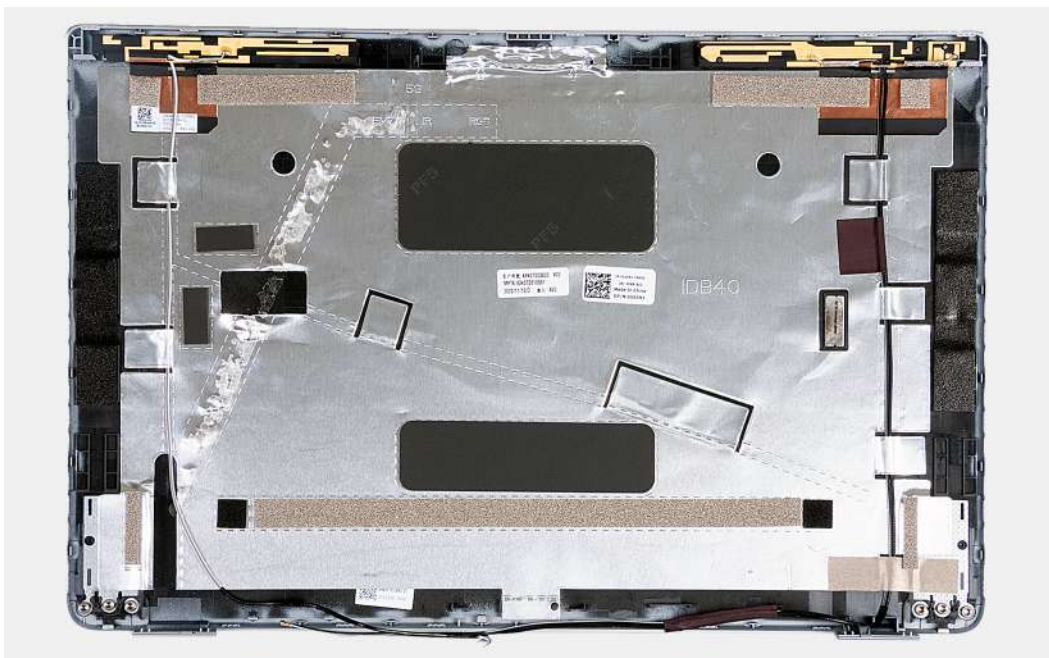

**Figure 51. Removing the display back cover**

#### Steps

After performing the steps in the pre-requisites, we are left with the display back cover.

For computers shipped with a G-sensor, the G-sensor daughter board is part of the display back cover. DO NOT remove it from the display back cover.



## Installing the display back cover

**CAUTION:** The information in this section is intended for authorized service technicians only.

### Prerequisites

If you are replacing a component, remove the existing component before performing the installation process.

### About this task

The following images indicate the location of the display back cover and provide a visual representation of the installation procedure.

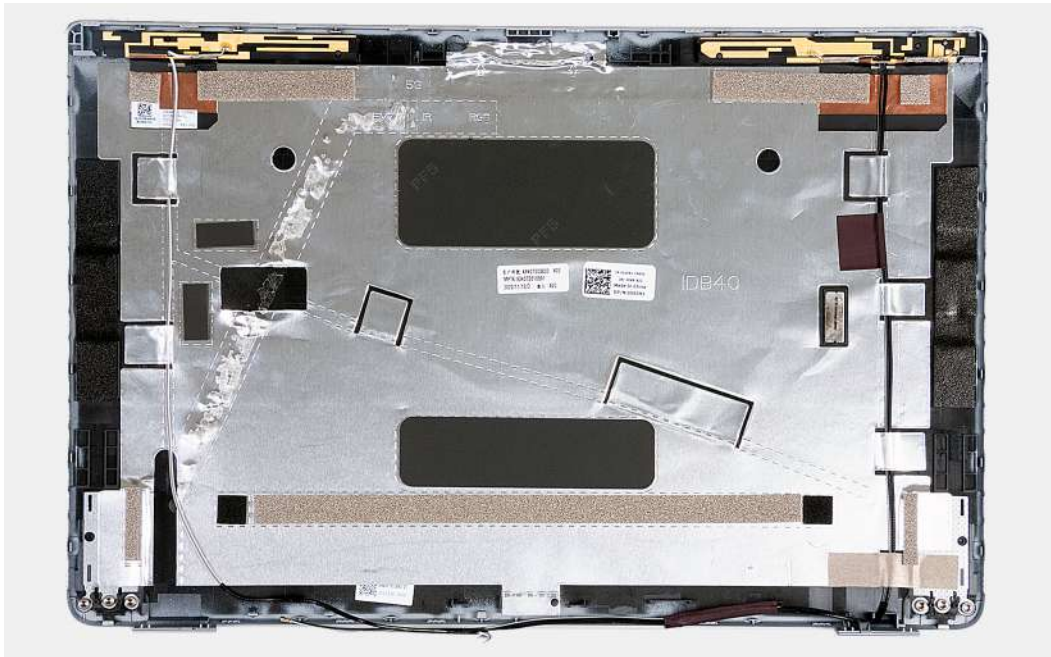

**Figure 52. Installing the display back cover**

For computers shipped with a G-sensor, the G-sensor daughter board is part of the display back cover. DO NOT remove it from the display back cover.

### Steps

Place the display back cover on a flat surface.

### Next steps

1. Install the [display cable](#).
2. Install the [display hinges](#).
3. Install the [camera module](#).
4. Install the [display panel](#).
5. Install the [display bezel](#).
6. Install the [display assembly](#).
7. Install the [WWAN card](#).
8. Install the [wireless card](#).
9. Install the [base cover](#).
10. Install the [nanoSIM card](#).
11. Follow the procedure in [After working inside your computer](#).

# System board

## Removing the system board

**CAUTION:** The information in this section is intended for authorized service technicians only.

### Prerequisites

1. Follow the procedure in [Before working inside your computer](#).
2. Remove the [nanoSIM card](#).
3. Remove the [base cover](#).
4. Remove the [battery](#).
5. Remove the [memory module](#).
6. Remove the [M.2 2230 solid-state drive](#).
7. Remove the [wireless card](#).
8. Remove the [WWAN card](#).
9. Remove the [fan](#).
10. Remove the [heat sink](#).
11. Remove the [assembly inner frame](#).

### About this task

The following images indicate the system board connectors.

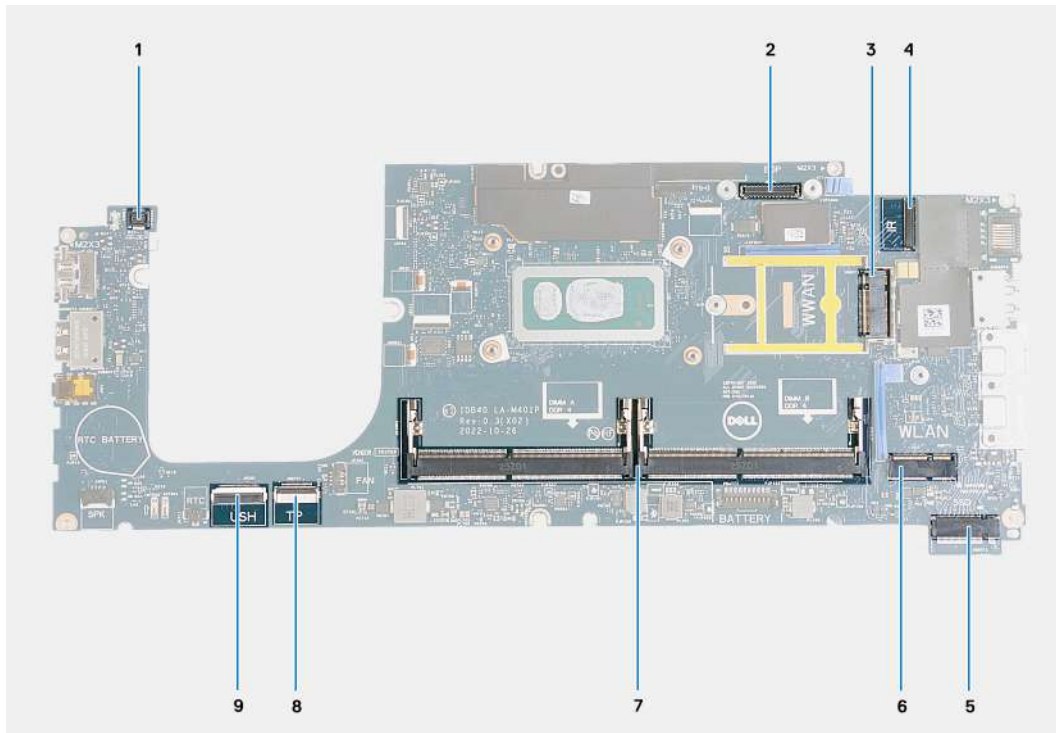

**Figure 53. System board connectors**

- |                                       |                              |
|---------------------------------------|------------------------------|
| 1. Fingerprint-reader cable connector | 2. Display cable connector   |
| 3. WWAN card slot                     | 4. Camera/IR cable connector |
| 5. Solid-state drive slot             | 6. Wireless card slot        |
| 7. Memory modules                     | 8. Touchpad cable connector  |
| 9. USH cable connector                |                              |

The following images indicate the location of the system board and provide a visual representation of the removal procedure.

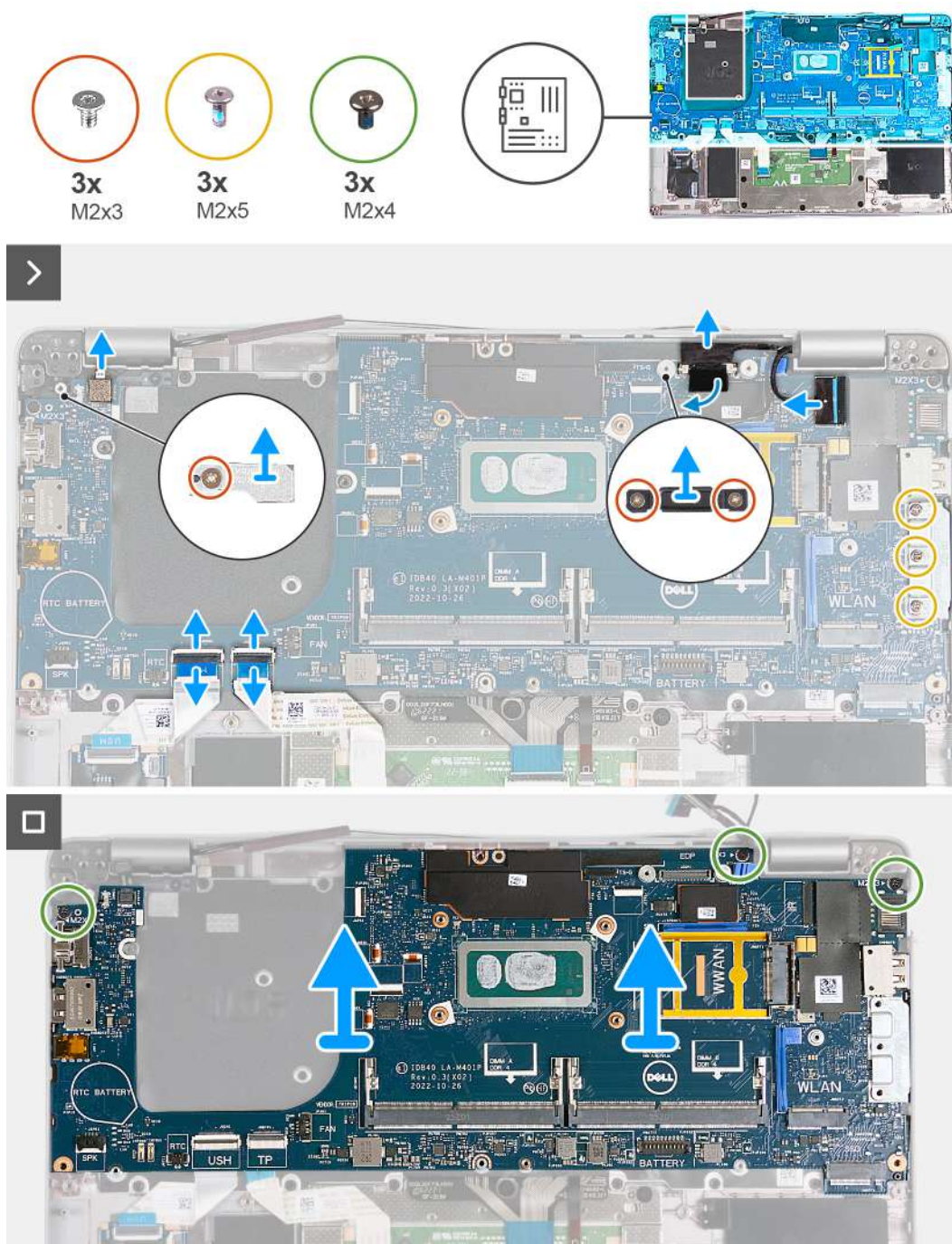

**Figure 54. Removing the system board**

**Steps**

1. Remove the screw (M2x3) that secures the WWAN card support frame to the palm-rest assembly.
2. Lift the WWAN card support frame off the palm-rest assembly.
3. Remove the screw (M2x3) that secures the fingerprint reader bracket to the palm-rest assembly.
4. Lift the fingerprint reader bracket off the palm-rest assembly.
5. Remove the two screws (M2x3) that secures the display cable bracket to the palm-rest assembly.
6. Lift the display cable bracket off the palm-rest assembly.
7. Open the latch and disconnect the USH cable from the USH module.
8. Open the latch and disconnect the touchpad cable from the touchpad module.
9. Remove the three screws (M2x5) that secure the USB Type-C bracket to the palm-rest assembly.

10. Lift the USB Type-C bracket off the palm-rest assembly.
11. Remove the three screws (M2x4) that secure the system board to the palm-rest assembly.
12. Lift the system board off the palm-rest assembly.
  - NOTE:** For computers shipped with a 4G WWAN card, the WWAN card support frame MUST be transferred to the replacement system board.
  - NOTE:** For models shipped with a 5G WWAN card, the WWAN card thermal pad MUST be transferred to the replacement system board.
  - NOTE:** The system board includes a USB Type-C bracket which must NOT be removed.
  - NOTE:** For models shipped with a U15 system board, the system board includes two power shielding covers which must NOT be removed.

## Installing the system board

**CAUTION:** The information in this section is intended for authorized service technicians only.

### Prerequisites

If you are replacing a component, remove the existing component before performing the installation process.

### About this task

The following images indicate the system board connectors.

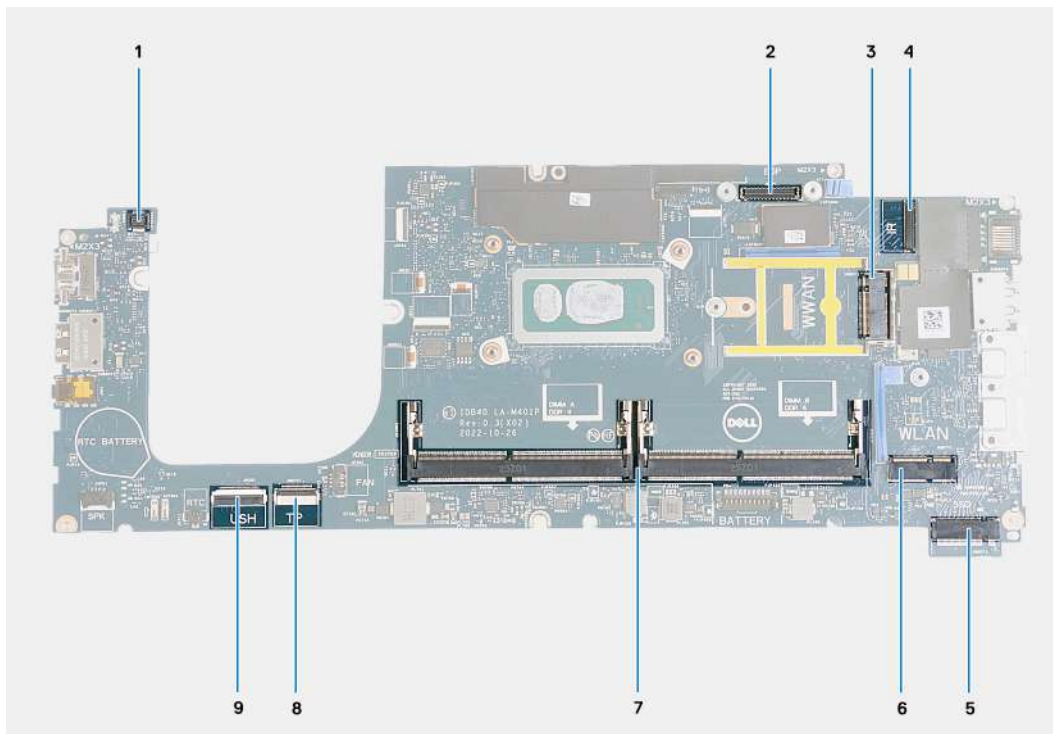

**Figure 55. System board connectors**

- |                                       |                              |
|---------------------------------------|------------------------------|
| 1. Fingerprint-reader cable connector | 2. Display cable connector   |
| 3. WWAN card slot                     | 4. Camera/IR cable connector |
| 5. Solid-state drive slot             | 6. Wireless card slot        |
| 7. Memory modules                     | 8. Touchpad cable connector  |
| 9. USH cable connector                |                              |

The following images indicate the location of the system board and provide a visual representation of the installation procedure.

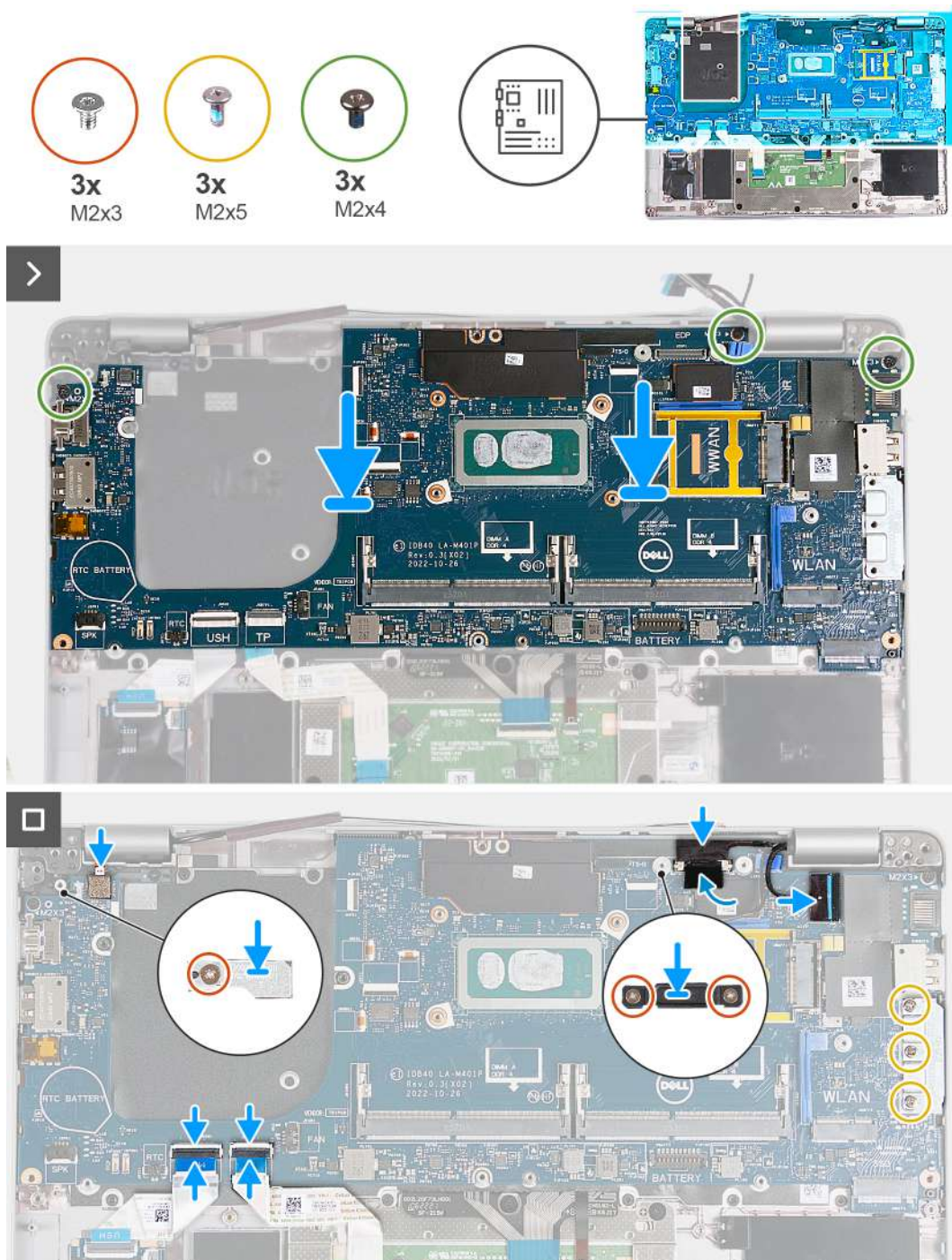

**Figure 56. Installing the system board**

- i** **NOTE:** For computers shipped with a 4G WWAN card, the WWAN card support frame **MUST** be transferred to the replacement system board.
- i** **NOTE:** For models shipped with a 5G WWAN card, the WWAN card thermal pad **MUST** be transferred to the replacement system board.
- i** **NOTE:** The system board includes a USB Type-C bracket which must **NOT** be removed.
- i** **NOTE:**

For models shipped with a U15 system board, the system board includes two power shielding covers which must NOT be removed.

### Steps

1. Align the screw holes on the system board with the screw holes on the palm-rest assembly.
2. Replace the three screws (M2x4) that secure the system board to the palm-rest assembly.
3. Align the screw holes on the USB Type-C bracket with the screw holes on the palm-rest assembly.
4. Replace the three screws (M2x5) that secure the USB Type-C bracket to the palm-rest assembly.
5. Connect the USH cable to the connector on the system board and close the latch to secure the cable.
6. Connect the touchpad cable to the connector on the touchpad module and close the latch to secure the cable.
7. Align the screw hole on the display cable bracket with the screw hole on the palm-rest assembly.
8. Replace the two screws (M2x3) that secure the display cable bracket to the palm-rest assembly.
9. Align the screw hole on the fingerprint reader bracket with the screw hole on the palm-rest assembly.
10. Replace the screw (M2x3) that secures the fingerprint reader bracket to the palm-rest assembly.
11. Align the screw hole on the WWAN card support frame with the screw hole on the palm-rest assembly.
12. Replace the screw (M2x3) that secures the WWAN card support frame to the palm-rest assembly.

### Next steps

1. Install the [assembly inner frame](#).
2. Install the [heat sink](#).
3. Install the [fan](#).
4. Install the [WWAN card](#).
5. Install the [wireless card](#).
6. Install the [M.2 2230 solid-state drive](#).
7. Install the [memory module](#).
8. Install the [battery](#).
9. Install the [base cover](#).
10. Install the [nanoSIM card](#).
11. Follow the procedure in [After working inside your computer](#).

## Smart card reader

### Removing the smart card reader

 **CAUTION:** The information in this section is intended for authorized service technicians only.

#### Prerequisites

1. Follow the procedure in [Before working inside your computer](#).
2. Remove the [nanoSIM card](#).
3. Remove the [base cover](#).
4. Remove the [battery](#).
5. Remove the [memory module](#).
6. Remove the [M.2 2230 solid-state drive](#).
7. Remove the [wireless card](#).
8. Remove the [WWAN card](#).
9. Remove the [fan](#).
10. Remove the [heat sink](#).
11. Remove the [speakers](#).
12. Remove the [assembly inner frame](#).
13. Remove the [system board](#).

**NOTE:** The system board can be removed and installed with the heat sink attached to simplify the procedure and preserve the thermal bond.

### About this task

This procedure is applicable to computers shipped with smart card reader.

The following images indicate the location of the smart card reader and provide a visual representation of the removal procedure.

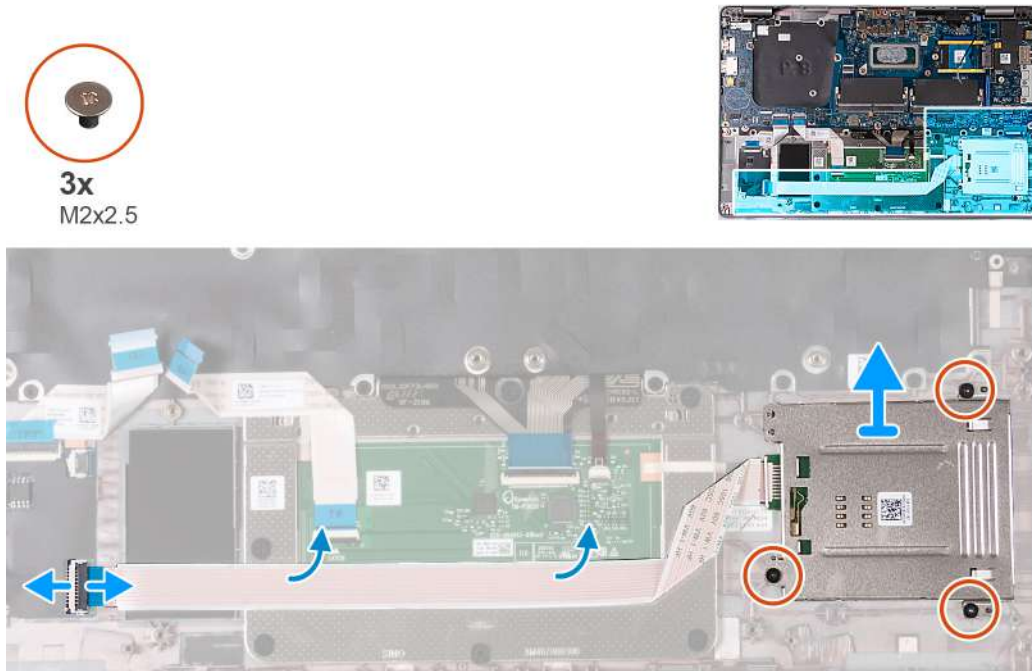

**Figure 57. Removing the smart card reader**

### Steps

1. Open the latch and disconnect the smart card reader cable from the connector on the USH board.
2. Peel the smart card reader cable.
3. Remove the three screws (M2x2.5) that secure the smart card reader to the palm-rest assembly.
4. Lift the smart card reader off the palm-rest assembly.

## Installing the smart card reader

**CAUTION:** The information in this section is intended for authorized service technicians only.

### Prerequisites

If you are replacing a component, remove the existing component before performing the installation process.

### About this task

This procedure is applicable to computers shipped with smart card reader.

The following images indicate the location of the smart card reader and provide a visual representation of the installation procedure.

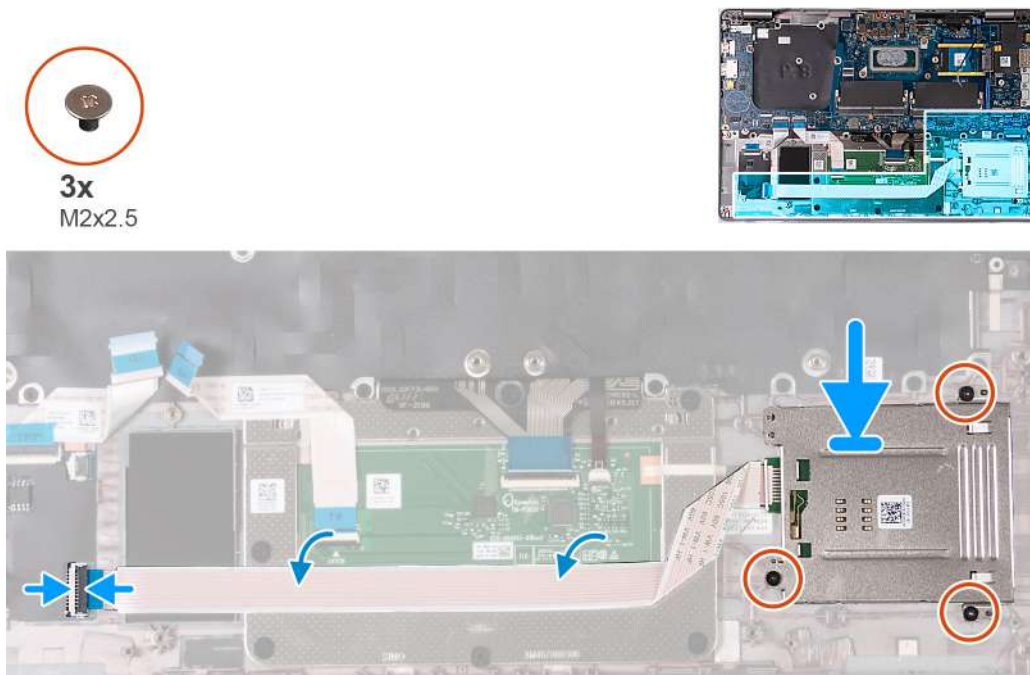

**Figure 58. Installing the smart card reader**

### Steps

1. Using the alignment posts, align and place the smart card reader on the palm-rest assembly.
2. Replace the three (M2x2.5) screws to secure the smart card reader to the palm-rest assembly.
3. Adhere the smart card reader cable to the palm-rest assembly.
4. Connect the smart card reader cable to the connector on the USH board.

### Next steps

1. Install the [system board](#).
  - i** **NOTE:** The system board can be removed and installed with the heatsink attached to simplify the procedure and preserve the thermal bond.
2. Install the [assembly inner frame](#).
3. Install the [speakers](#).
4. Install the [heat sink](#).
5. Install the [fan](#).
6. Install the [WWAN card](#).
7. Install the [wireless card](#).
8. Install the [M.2 2230 solid-state drive](#).
9. Install the [memory module](#).
10. Install the [battery](#).
11. Install the [base cover](#).
12. Install the [nanoSIM card](#).
13. Follow the procedure in [After working inside your computer](#).

## Power-button board

### Removing the power-button board

**⚠ CAUTION:** The information in this section is intended for authorized service technicians only.



## Prerequisites

1. Follow the procedure in [Before working inside your computer](#).
2. Remove the [nanoSIM card](#).
3. Remove the [base cover](#).
4. Remove the [battery](#).
5. Remove the [memory module](#).
6. Remove the [M.2 2230 solid-state drive](#).
7. Remove the [wireless card](#).
8. Remove the [WWAN card](#).
9. Remove the [fan](#).
10. Remove the [heat sink](#).
11. Remove the [speakers](#).
12. Remove the [assembly inner frame](#).
13. Remove the [system board](#).

**NOTE:** The system board can be removed and installed with the heat sink attached to simplify the procedure and preserve the thermal bond.

## About this task

The following images indicate the location of the power-button board and provide a visual representation of the removal procedure.

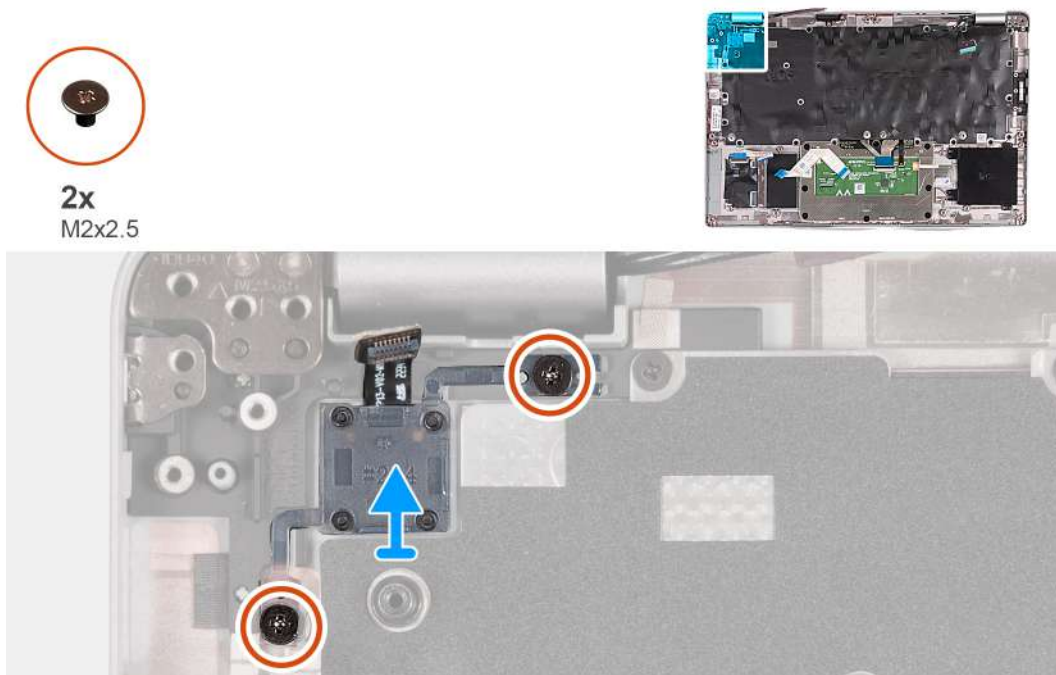

**Figure 59. Removing the power-button board**

## Steps

1. Remove the two (M2x2.5) screws that secure the power-button board to the palm-rest assembly.
2. Lift the power-button board, along with its cable, off the palm-rest assembly.

## Installing the power-button board

**CAUTION:** The information in this section is intended for authorized service technicians only.

## Prerequisites

If you are replacing a component, remove the existing component before performing the installation process.

## About this task

The following images indicate the location of the power-button board and provide a visual representation of the installation procedure.

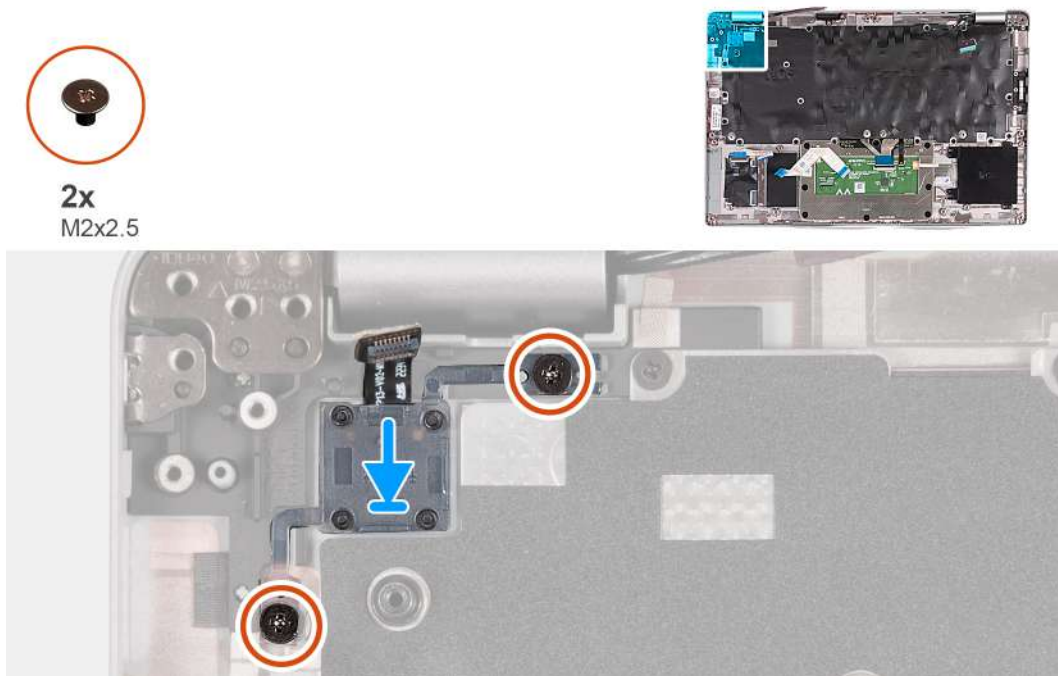

**Figure 60. Installing the power-button board**

## Steps

1. Align and place the power-button board on the palm-rest assembly.
2. Replace the two (M2x2.5) screws to secure the power-button board to the palm-rest assembly.

## Next steps

1. Install the [system board](#).  
**i** **NOTE:** The system board can be removed and installed with the heatsink attached to simplify the procedure and preserve the thermal bond.
2. Install the [assembly inner frame](#).
3. Install the [speakers](#).
4. Install the [heat sink](#).
5. Install the [fan](#).
6. Install the [WWAN card](#).
7. Install the [wireless card](#).
8. Install the [M.2 2230 solid-state drive](#).
9. Install the [memory module](#).
10. Install the [battery](#).
11. Install the [base cover](#).
12. Install the [nanoSIM card](#).
13. Follow the procedure in [After working inside your computer](#).

# Keyboard

## Removing the keyboard

 **CAUTION:** The information in this section is intended for authorized service technicians only.

### Prerequisites

1. Follow the procedure in [Before working inside your computer](#).
2. Remove the [nanoSIM card](#).
3. Remove the [base cover](#).
4. Remove the [battery](#).
5. Remove the [memory module](#).
6. Remove the [M.2 2230 solid-state drive](#).
7. Remove the [wireless card](#).
8. Remove the [WWAN card](#).
9. Remove the [fan](#).
10. Remove the [heat sink](#).
11. Remove the [speakers](#).
12. Remove the [assembly inner frame](#).
13. Remove the [system board](#).

 **NOTE:** The system board can be removed and installed with the heat sink attached to simplify the procedure and preserve the thermal bond.

### About this task

The following images indicate the location of the keyboard and provide a visual representation of the removal procedure.



**Figure 61. Removing the keyboard**

### Steps

1. Open the latch and disconnect the keyboard cable from the touchpad.
2. Open the latch and disconnect the keyboard backlit cable from the touchpad.
3. Remove the seventeen screws (M2x2) that secure the keyboard bracket to the palm-rest assembly.
  - ⓘ **NOTE:** One of the screws is located under the touchpad cable.
4. Lift the keyboard bracket off the palm-rest assembly.
5. Turn the keyboard bracket over.
6. Remove the four screws (M2x2) that secure the keyboard to the keyboard bracket.
7. Lift the keyboard off the keyboard bracket.

## Installing the keyboard

**CAUTION:** The information in this section is intended for authorized service technicians only.

### Prerequisites

If you are replacing a component, remove the existing component before performing the installation process.

### About this task

The following images indicate the location of the keyboard and provide a visual representation of the installation procedure.



Figure 62. Installing the keyboard

## Steps

1. Align and place the keyboard on the keyboard bracket.
2. Replace the four screws (M2x2) to secure the keyboard to the keyboard bracket.
3. Turn the keyboard bracket over.
4. Align and place the keyboard bracket on the palm-rest assembly.
5. Replace the seventeen screws (M2x2) that secure the keyboard bracket to the palm-rest assembly.  
 **NOTE:** One of the screws is located under the touchpad cable.
6. Connect the keyboard backlit cable to the connector on the touchpad and close the latch to secure the cable.
7. Connect the keyboard cable to the connector on the system board and close the latch to secure the cable.

## Next steps

1. Install the [system board](#).  
 **NOTE:** The system board can be removed and installed with the heat sink attached to simplify the procedure and preserve the thermal bond.
2. Install the [assembly inner frame](#).
3. Install the [speakers](#).
4. Install the [heat sink](#).
5. Install the [fan](#).
6. Install the [WWAN card](#).
7. Install the [wireless card](#).
8. Install the [M.2 2230 solid-state drive](#).
9. Install the [memory module](#).
10. Install the [battery](#).
11. Install the [base cover](#).
12. Install the [nanoSIM card](#).
13. Follow the procedure in [After working inside your computer](#).

# Palm-rest assembly

## Removing the palm-rest assembly

 **CAUTION:** The information in this section is intended for authorized service technicians only.

### Prerequisites

1. Follow the procedure in [Before working inside your computer](#).
2. Remove the [nanoSIM card](#).
3. Remove the [base cover](#).
4. Remove the [battery](#).
5. Remove the [memory module](#).
6. Remove the [M.2 2230 solid-state drive](#).
7. Remove the [wireless card](#).
8. Remove the [WWAN card](#).
9. Remove the [fan](#).
10. Remove the [heat sink](#).
11. Remove the [speakers](#).
12. Remove the [assembly inner frame](#).
13. Remove the [display assembly](#).
14. Remove the [system board](#).  
 **NOTE:** The system board can be removed and installed with the heat sink attached to simplify the procedure and preserve the thermal bond.
15. Install the [power-button board](#).

16. Remove the [keyboard](#).

**About this task**

The following images indicate the location of the palm-rest assembly and provide a visual representation of the removal procedure.



**Figure 63. Removing the palm-rest assembly**

**Steps**

After performing the steps in the pre-requisites, we are left with the palm-rest assembly.

## Installing the palm-rest assembly

**CAUTION:** The information in this section is intended for authorized service technicians only.

**Prerequisites**

If you are replacing a component, remove the existing component before performing the installation process.

**About this task**

The following images indicate the location of the palm-rest assembly and provide a visual representation of the installation procedure.



**Figure 64. Installing the palm-rest assembly**

### Steps

Place the palm-rest assembly on a flat surface.

### Next steps

1. Install the [keyboard](#).
2. Install the [power-button board](#).
3. Install the [system board](#).
4. Install the [display assembly](#).
5. Install the [assembly inner frame](#).
6. Install the [speakers](#).
7. Install the [heat sink](#).
8. Install the [fan](#).
9. Install the [WWAN card](#).
10. Install the [wireless card](#).
11. Install the [M.2 2230 solid-state drive](#).
12. Install the [memory module](#).
13. Install the [battery](#).
14. Install the [base cover](#).
15. Install the [nanoSIM card](#).
16. Follow the procedure in [After working inside your computer](#).

## Dummy SIM-card slot filler

### Removing the dummy SIM-card slot filler

**⚠ CAUTION:** The information in this section is intended for authorized service technicians only.



## Prerequisites

1. Follow the procedure in [Before working inside your computer](#).
2. Remove the [nanoSIM card](#).
3. Remove the [base cover](#).
4. Remove the [battery](#).
5. Remove the [memory module](#).
6. Remove the [M.2 2230 solid-state drive](#).
7. Remove the [wireless card](#).
8. Remove the [WWAN card](#).
9. Remove the [fan](#).
10. Remove the [heat sink](#).
11. Remove the [speakers](#).
12. Remove the [assembly inner frame](#).
13. Remove the [display assembly](#).
14. Remove the [system board](#).
15. Install the [power-button board](#).
16. Remove the [keyboard](#).
17. Remove the [palm-rest assembly](#).

## About this task

**NOTE:** For models shipped with WLAN antennas only, the dummy SIM-card slot filler is a separate service part and is not included with replacement palm rest. As a result, the dummy SIM-card slot filler must be removed and then reinstalled when replacing the palm-rest assembly.

The following image indicates the dummy SIM-card slot filler and provides a visual representation of the dummy SIM-card slot filler removal procedure.



Figure 65. Removing the dummy SIM-card slot filler

## Steps

Using a plastic scribe, push the dummy SIM-card slot filler outwards to remove it from the palm-rest assembly.

## Installing the dummy SIM-card slot filler

**CAUTION:** The information in this section is intended for authorized service technicians only.

## Prerequisites

If you are replacing a component, remove the existing component before performing the installation process.

## About this task

The following image indicates the location of the dummy SIM-card slot filler and provides a visual representation of the dummy SIM-card slot filler installation procedure.



**Figure 66. Installing the dummy SIM-card slot filler**

## Steps

Place the palm-rest assembly on a flat surface.

## Next steps

1. Install the [palm-rest assembly](#).
2. Install the [keyboard](#).
3. Install the [power-button board](#).
4. Install the [system board](#).
5. Install the [display assembly](#).
6. Install the [assembly inner frame](#).
7. Install the [speakers](#).
8. Install the [heat sink](#).
9. Install the [fan](#).
10. Install the [WWAN card](#).
11. Install the [wireless card](#).
12. Install the [M.2 2230 solid-state drive](#).
13. Install the [memory module](#).
14. Install the [battery](#).
15. Install the [base cover](#).
16. Install the [nanoSIM card](#).
17. Follow the procedure in [After working inside your computer](#).

# Software

This chapter details the supported operating systems along with instructions on how to install the drivers.

## Operating system

Your Precision 3480 supports the following operating systems:

- Windows 11 Home, 64-bit
- Windows 11 Pro, 64-bit
- Microsoft Windows 11 Pro downgrade (Win 10 Pro image FI + Win 11 Pro DPK)
- Windows 10 China G-SKU, 64-bit
- Ubuntu 22.04 LTS, 64-bit

## Drivers and downloads

When troubleshooting, downloading or installing drivers it is recommended that you read the Dell Knowledge Base article, Drivers and Downloads FAQ [000123347](#).

# BIOS setup

**CAUTION:** Unless you are an expert computer user, do not change the settings in the BIOS Setup program. Certain changes can make your computer work incorrectly.

**NOTE:** Depending on the computer and its installed devices, the items listed in this section may or may not be displayed.

**NOTE:** Before you change BIOS Setup program, it is recommended that you write down the BIOS Setup program screen information for future reference.

Use the BIOS Setup program for the following purposes:

- Get information about the hardware installed in your computer, such as the amount of RAM and the size of the hard drive.
- Change the system configuration information.
- Set or change a user-selectable option, such as the user password, type of hard drive installed, and enabling or disabling base devices.

## Entering BIOS setup program

### About this task

Turn on (or restart) your computer and press F2 immediately.

## Navigation keys

**NOTE:** For most of the System Setup options, changes that you make are recorded but do not take effect until you restart the system.

**Table 36. Navigation keys**

Keys	Navigation
Up arrow	Moves to the previous field.
Down arrow	Moves to the next field.
Enter	Selects a value in the selected field (if applicable) or follow the link in the field.
Spacebar	Expands or collapses a drop-down list, if applicable.
Tab	Moves to the next focus area. <b>NOTE:</b> For the standard graphics browser only.
Esc	Moves to the previous page until you view the main screen. Pressing Esc in the main screen displays a message that prompts you to save any unsaved changes and restarts the system.

## One Time Boot menu

To enter **One Time Boot menu**, turn on your computer, and then press F12 immediately.

**NOTE:** It is recommended to shutdown the computer if it is on.

The one-time boot menu displays the devices that you can boot from including the diagnostic option. The boot menu options are:

- Removable Drive (if available)
- STXXXX Drive (if available)
- **i** **NOTE:** XXX denotes the SATA drive number.
- Optical Drive (if available)
- SATA Hard Drive (if available)
- Diagnostics

The boot sequence screen also displays the option to access the System Setup screen.

## System setup options

**i** **NOTE:** Depending on your computer and its installed devices, the items listed in this section may or may not appear.

**Table 37. System setup options—System information menu**

Overview	
<b>Precision 3480</b>	
BIOS Version	Displays the BIOS version number.
Service Tag	Displays the Service Tag of the computer.
Asset Tag	Displays the Asset Tag of the computer.
Manufacture Date	Displays the manufacture date of the computer.
Ownership Date	Displays the ownership date of the computer.
Express Service Code	Displays the express service code of the computer.
Ownership Tag	Displays the ownership tag of the computer.
Signed Firmware Update	Displays whether the Signed Firmware Update is enabled on your computer.
<b>Battery</b>	
Battery Level	Displays the battery level of the computer.
Battery State	Displays the battery state of the computer.
Health	Displays the battery health of the computer.
AC Adapter	Displays whether the AC adapter is connected or not.
Battery Life Type	Displays the battery type of the computer.
<b>Processor</b>	
Processor Type	Displays the processor type.
Maximum Clock Speed	Displays the maximum processor clock speed.
Minimum Clock Speed	Displays the minimum processor clock speed.
Current Clock Speed	Displays the current processor clock speed.
Core Count	Displays the number of cores on the processor.
Processor ID	Displays the processor identification code.
Processor L2 Cache	Displays the processor L2 Cache size.
Processor L3 Cache	Displays the processor L3 Cache size.
Microcode Version	Displays the microcode version.
Intel Hyper-Threading Capable	Displays whether the processor is Hyper-Threading (HT) capable.
64-Bit Technology	Displays whether 64-bit technology is used.

**Table 37. System setup options—System information menu (continued)**

<b>Overview</b>	
<b>Memory</b>	
Memory Installed	Displays the total computer memory installed.
Memory Available	Displays the total computer memory available.
Memory Speed	Displays the memory speed.
Memory Channel Mode	Displays single or dual channel mode.
Memory Technology	Displays the technology used for the memory.
DIMM_SLOT B	Displays the DIMM_SLOT B memory size.
DIMM_SLOT A	Displays the DIMM_SLOT A memory size.
<b>Devices</b>	
Panel Type	Displays the Panel Type of the computer.
Privacy Screen	Displays whether privacy screen is installed or not.
Video Controller	Displays the video controller type of the computer.
Video Memory	Displays the video memory information of the computer.
Wi-Fi Device	Displays the wireless device information of the computer.
Native Resolution	Displays the native resolution of the computer.
Video BIOS Version	Displays the video BIOS version of the computer.
Audio Controller	Displays the audio controller information of the computer.
Bluetooth Device	Displays the Bluetooth device information of the computer.
LOM MAC Address	Displays the LAN On Motherboard (LOM) MAC address of the computer.
Pass Through MAC Address	Displays the pass through MAC address of the computer.
Cellular Device	Displays the cellular device information of the computer.
dGPU Video Controller	Displays the dGPU video controller type of the computer.

**Table 38. System setup options—Boot Configuration menu**

<b>Boot Configuration</b>	
<b>Boot Sequence</b>	
Boot Mode: UEFI only	Set the order BIOS searches devices when finding an operating system to boot.
<b>Secure Boot</b>	
Enable Secure Boot	Enable or disable the secure boot feature. By default, the option is disabled.
Enable Microsoft UEFI CA	Enable or disable the Microsoft UEFI CA. By default, the option is enabled.
Secure Boot Mode	Enable or disable to change the secure boot mode options. By default, the <b>Deployed Mode</b> is enabled.
<b>Expert Key Management</b>	
Enable Custom Mode	Enable or disable custom mode. By default, the <b>custom mode</b> option is not enabled.
Custom Mode Key Management	Select the custom values for expert key management.

**Table 39. System setup options—Integrated Devices menu**

<b>Integrated Devices</b>	
<b>Date/Time</b>	Displays the current date in MM/DD/YYYY format and current time in HH:MM:SS AM/PM format.
<b>Camera</b>	Enables or disable the camera. By default, the <b>Enable Camera</b> option is selected.
<b>Audio</b>	
Enable Audio	Enables or disable the audio. By default, the <b>Enable Audio</b> option is selected.
Enable Microphone	Enables or disable the microphone. By default, the <b>Enable Microphone</b> option is enabled.
Enable Internal Speaker	Enables or disable the internal speaker. By default, the <b>Enable Internal Speaker</b> option is enabled
<b>USB/Thunderbolt Configuration</b>	<ul style="list-style-type: none"> <li>• Enable or disable booting from USB mass storage devices connected to external USB ports. By default, the <b>Enable External USB Ports</b> option is enabled.</li> <li>• Enable or disable booting from USB mass storage devices such as external hard drive, optical drive, and USB drive. By default, the <b>Enable USB Boot Support</b> option is enabled.</li> </ul>
<b>Enable Thunderbolt Technology Support</b>	Enable or disable the associated ports and adapters. By default, the <b>Enable Thunderbolt Technology Support</b> option is selected.
<b>Enable Thunderbolt Boot Support</b>	Enable or disable the Thunderbolt adapter peripheral device and USB devices connected to the Thunderbolt adapter to be used during BIOS Pre-boot. By default, the <b>Enable Thunderbolt Boot Support</b> option is disabled.
<b>Enable Thunderbolt (and PCIe behind TBT) pre-boot modules</b>	Enable or disable the PCIe devices that are connected through a Thunderbolt adapter to execute the PCIe devices UEFI Option ROM (if present) during pre-boot. By default, the <b>Enable Thunderbolt (and PCIe behind TBT) pre-boot modules</b> option is disabled.
<b>Disable USB4 PCIE Tunneling</b>	Disable the USB4 PCIE Tunneling option. By default, the <b>Disable USB4 PCIE Tunneling</b> option is disabled.
<b>Video/Power only on Type-C Ports</b>	Enable or disable the Type-C port functionality to video or only power. By default, the <b>Video/Power only on Type-C Ports</b> option is disabled.
<b>Type-C Dock Override</b>	
Type C Dock Audio	Allows you to use Audio on Dell Dock external ports.
Type C Dock Lan	Allows you to use LAN on Dell Dock external ports.
<b>Miscellaneous Devices</b>	Enable or disable Fingerprint Reader device. By default, the <b>Enable Fingerprint Reader Device</b> option is enabled.
<b>Unobtrusive Mode</b>	
Enable Unobtrusive Mode	Enable or disable all the computer light and sound. By default, the <b>Enable Unobtrusive Mode</b> option is disabled.

**Table 40. System setup options—Storage menu**

Storage	
<b>SATA/NVMe Operation</b>	
SATA/NVMe Operation	Set the operating mode of the integrated storage device controller. By default, the <b>RAID On</b> option is enabled.
<b>Storage Interface</b>	
Storage interface	Enable or disable port enablement. By default, the <b>Port Enablement</b> option is enabled.
<b>SMART Reporting</b>	
Enable SMART Reporting	Enable or disable Self-Monitoring, Analysis, and Reporting Technology (SMART) during computer startup. By default, the <b>Enable SMART Reporting</b> option is not enabled.
<b>Drive Information</b>	Displays the drive information of the computer.

**Table 41. System setup options—Display menu**

Display	
<b>Display Brightness</b>	
Brightness on battery power	Enable to set screen brightness when the computer is running on battery power.
Brightness on AC power	Enable to set screen brightness when the computer is running on AC power.
<b>Touchscreen</b>	
	Enable or disable touchscreen. By default, the option is <b>enabled</b> .
<b>Full Screen Logo</b>	
	Enable or disable full screen logo. By default, the option is <b>disabled</b> .

**Table 42. System setup options—Connection menu**

Connection	
<b>Network Controller Configuration</b>	
Integrated NIC	Controls the on-board LAN controller. By default, the <b>Enabled with PXE</b> option is enabled.
<b>Wireless Device Enable</b>	
WWAN/GPS	Enable or disable the internal WWAN/GPS device. By default, the option is enabled.
WLAN	Enable or disable the internal WLAN device. By default, the option is enabled.
Bluetooth	Enable or disable the internal Bluetooth device. By default, the option is enabled.
Contactless smartcard/NFC	Enable or disable the internal Contactless smartcard/NFC device. By default, the option is enabled.
<b>Enable UEFI Network Stack</b>	Enable or disable UEFI Network Stack and controls the on-board LAN Controller. By default, the <b>Enable UEFI Network Stack</b> option are enabled.



**Table 42. System setup options—Connection menu (continued)**

Connection	
<b>Wireless Radio Control</b>	
Control WLAN radio	Sense the connection of the computer to a wired network and subsequently disable the selected wireless radios (WLAN). By default, the option is disabled.
Control WWAN radio	Sense the connection of the computer to a wired network and subsequently disable the selected wireless radios (WWAN). By default, the option is disabled.
<b>HTTP(s) Boot Feature</b>	
HTTP(s) Boot	Enable or disable the HTTPs Boot feature. By default, the <b>HTTP(s) Boot</b> option is enabled.
HTTP(s) Boot Modes	With Auto Mode, the HTTPs Boot extracts Boot URL from the DHCP. With Manual Mode, the HTTPs Boot reads Boot URL from the user-provided data. By default, the <b>Auto Mode</b> option is enabled.

**Table 43. System setup options—Power menu**

Power	
<b>Battery Configuration</b>	Enables the computer to run on battery during peak power usage hours. Use the table <b>Custom Charge Start</b> and <b>Custom Charge Stop</b> , to prevent AC power usage between certain times of each day. By default, the <b>Adaptive</b> option is enabled.
<b>Advanced Configuration</b>	
Enable Advanced Battery Charge Configuration	Enable or disable the advanced battery charge configuration to support maximize battery health while supporting heavy use during the work day. By default, the <b>Enable Advanced Battery Charge Configuration</b> option is disabled.
<b>Peak Shift</b>	
Enable Peak Shift	Enables the computer to run on battery during peak power usage hours. By default, the <b>Enable Peak Shift</b> option is disabled.
<b>Type-C Connector Power</b>	
Type-C Connector Power	Set the maximum power that can be drawn from the Type-C connector.
<b>USB PowerShare</b>	
Enable USB PowerShare	Enable or disable the USB PowerShare. By default, the <b>Enable USB PowerShare</b> option is disabled.
<b>Thermal Management</b>	Enables to cool the fan and processor heat management to adjust the computer performance, noise, and temperature. By default, the <b>Optimized</b> option is enabled.
<b>USB Wake Support</b>	
Wake on Dell USB-C Dock	When enabled, connecting a Dell USB-C Dock will wake the computer from standby. By default, the <b>Wake on Dell USB-C Dock</b> option is enabled.
<b>Block Sleep</b>	Enables to block entering sleep (S3) mode in the operating system. By default, the <b>Block Sleep</b> option is disabled.

**Table 43. System setup options—Power menu (continued)**

Power	
<b>Lid Switch</b>	Enable or disable the lid switch. By default, the <b>Lid Switch</b> option is enabled.
<b>Intel Speed Shift Technology</b>	Enable or disable the Intel speed shift technology support. By default, the <b>Intel Speed Shift Technology</b> option is enabled.

**Table 44. System setup options—Security menu**

Security	
<b>TPM 2.0 Security</b>	
TPM 2.0 Security On	Enable or disable TPM 2.0 security options. By default, the <b>TPM 2.0 Security On</b> option is enabled.
Attestation Enable	Enables to control whether the Trusted Platform Module (TPM) Endorsement Hierarchy is available to the operating system. By default, the <b>Attestation Enable</b> option is enabled.
Key Storage Enable	Enables to control whether the Trusted Platform Module (TPM) Storage Hierarchy is available to the operating system. By default, the <b>Key Storage Enable</b> option is enabled.
SHA-256	BIOS and the TPM will use the SHA-256 hash algorithm to extend measurements into the TPM PCRs during BIOS boot. By default, the <b>SHA-256</b> option is enabled.
Clear	Enables to clear the TPM owner information and returns the TPM to the default state. By default, the <b>Clear</b> option is disabled.
PPI ByPass for Clear Commands	Controls the TPM Physical Presence Interface (PPI). By default, the <b>PPI ByPass for clear Commands</b> option is disabled.
<b>Intel Total Memory Encryption</b>	
Multi-Key Total Memory Encryption	Enable or disable the Multi-Key Total Memory Encryption By default, the option is <b>disabled</b> .
<b>Chassis Intrusion</b>	
Clear Intrusion Warning	Enable or disable Clear Intrusion Warning. By default, the option is <b>disabled</b> .
Block Boot Until Cleared	Enable or disable Block Boot Until Cleared. By default, the option is <b>disabled</b> .
<b>SMM Security Mitigation</b>	
	Enable or disable SMM Security Mitigation. By default, the option is <b>enabled</b> .
<b>Data Wipe on Next Boot</b>	
Start Data Wipe	Enable or disable the data wipe on next boot. By default, the option is <b>enabled</b> .
<b>Absolute</b>	
Absolute	Enable or disable or permanently disable the BIOS module interface of the optional Absolute Persistence Module service from Absolute software.

**Table 44. System setup options—Security menu (continued)**

Security	
	By default, the option is <b>enabled</b> .
<b>UEFI Boot Path Security</b>	Controls whether or not the computer will prompt the user to enter the admin password (if set) when booting to a UEFI boot device from the F12 boot menu. By default, the <b>Always Except Internal HDD</b> option is enabled.
<b>Firmware Device Tamper Detection</b>	
Firmware Device Tamper Detection	Enable or disable the Firmware Device Tamper Detection. By default, the <b>Silent</b> option is <b>enabled</b> .
Clear Firmware Device Tamper Detection	Enable or disable the Clear Firmware Device Tamper Detection. By default, the option is <b>disabled</b> .

**Table 45. System setup options—Passwords menu**

Passwords	
<b>Admin Password</b>	Set, change, or delete the administrator password.
<b>System Password</b>	Set, change, or delete the system password.
<b>M.2 PCIe SSD-0</b>	Set, change, or delete the M.2 PCIe SSD-0 password.
<b>Password Configuration</b>	
Upper Case Letter	Reinforces password must have at least one upper case letter. By default, the option is disabled.
Lower Case Letter	Reinforces password must have at least one lower case letter. By default, the option is disabled.
Digit	Reinforces password must have at least one digit. By default, the option is disabled.
Special Character	Reinforces password must have at least one special character. By default, the option is disabled.
Minimum Characters	Set the minimum number of characters allowed for password.
<b>Password Bypass</b>	When enabled, this always prompts for computer and internal hard drive passwords when powered on from the off state. By default, the <b>Disabled</b> option is enabled.
<b>Password Changes</b>	
Allow Non-Admin Password Changes	Enable or disable to change computer and hard drive password without the need for admin password. By default, the option is enabled.
<b>Admin Setup Lockout</b>	Enable or disable Admin setup Lockout. By default, the option is <b>disabled</b> .
<b>Master Password Lockout</b>	Enable or disable Master Password Lockout. By default, the option is <b>disabled</b> .
<b>Allow Non-Admin PSID Revert</b>	
Enable Allow Non-Admin PSID Revert	Controls access to the Physical Security ID (PSID) revert of NVMe hard-drives from the Dell Security Manager prompt. By default, the option is <b>disabled</b> .

**Table 46. System setup options—Update, Recovery menu**

Update, Recovery	
<b>UEFI Capsule Firmware Updates</b>	Enable or disable BIOS updates through UEFI capsule update packages. By default, the option is enabled.
<b>BIOS Recovery from Hard Drive</b>	Enables the user to recover from certain corrupted BIOS conditions from a recovery file on the user primary hard drive or an external USB key. By default, the option is enabled.
<b>BIOS Downgrade</b> Allow BIOS Downgrade	Enable or disable the flashing of the computer firmware to previous revision is blocked. By default, the option is enabled.
<b>SupportAssist OS Recovery</b>	Enable or disable the boot flow for SupportAssist OS Recovery tool in the event of certain computer errors. By default, the option is enabled.
<b>BIOSConnect</b>	Enable or disable cloud Service OS recovery if the main operating system fails to boot with the number of failures equal to or greater than the value specified by the Auto OS Recovery Threshold setup option and local Service OS does not boot or is not installed. By default, the option is enabled.
<b>Dell Auto OS Recovery Threshold</b>	Controls the automatic boot flow for SupportAssist System Resolution Console and for Dell OS Recovery Tool. By default, the threshold value is set to 2.

**Table 47. System setup options—System Management menu**

System Management	
<b>Service Tag</b>	Display the Service Tag of the computer.
<b>Asset Tag</b>	Create a computer Asset Tag.
<b>AC Behavior</b> Wake on AC	Enable or disable the wake on AC option. By default, the option is disabled.
<b>Wake on LAN</b> Wake on LAN	Enable or disable the computer to power on by special LAN signals when it receives a wakeup signal from the WLAN. By default, the <b>Disabled</b> option is selected.
Auto on Time	Enable to set the computer to turn on automatically every day or on a preselected date and time. This option can be configured only if the Auto On Time is set to Everyday, Weekdays, or Selected Days. By default, the option is disabled.
<b>Intel AMT Capability</b>	Enable or disable Intel AMT Capability.
<b>Diagnostics</b> OS Agent Requests	Enable or disable OS agent requests capable of scheduling onboard diagnostics.
<b>Power-on-Self-Test Automatic Recovery</b>	Enable or disable Power-on-Self-Test Automatic Recovery.

**Table 48. System setup options—Keyboard menu**

Keyboard	
<b>Fn Lock Options</b>	By default, the Fn lock option is enabled.
<b>Keyboard Illumination</b>	Enables to change the keyboard illumination settings. By default, the <b>Dim</b> option is enabled.
<b>Keyboard Backlight Timeout on AC</b>	Set the timeout value for the keyboard backlight when an AC adapter is connected to the computer. By default, the <b>10 seconds</b> option is enabled.
<b>Keyboard Backlight Timeout on Battery</b>	Set the timeout value for the keyboard backlight when the is running only on battery power. By default, the <b>10 seconds</b> option is enabled.
<b>Device Configuration Hotkey Access</b>	Manages whether you can access device configuration screens through hotkeys during computer startup. By default, the option is <b>enabled</b> .

**Table 49. System setup options—Pre-boot Behavior menu**

Pre-boot Behavior	
<b>Adapter Warnings</b>	
Enable Adapter Warnings	Enable or disable the warning messages during boot when the adapters with less power capacity are detected. By default, the option is enabled.
<b>Warning and Errors</b>	Enable or disable the action to be done when a warning or error is encountered. By default, the <b>Prompt on Warnings and Errors</b> option is enabled.
<b>Fastboot</b>	Enable to set the speed of the boot process. By default, the <b>Thorough</b> option is enabled.
<b>Extend BIOS POST Time</b>	Set the BIOS POST time. By default, the <b>0 seconds</b> option is enabled.
<b>MAC Address Pass-Through</b>	Replaces the external NIC MAC address with the selected MAC address from the computer. By default, the <b>Passthrough MAC Address</b> option is enabled.
<b>Sign of Life</b>	Enable or disable early keyboard backlight. By default, the option is <b>enabled</b> .

**Table 50. System setup options—Virtualization Support menu**

Virtualization Support	
<b>Intel Virtualization Technology</b>	
Enable Intel Virtualization Technology (VT)	Specify whether a Virtual Machine Monitor (VMM) can utilize the additional hardware capabilities provided by Intel Virtualization Technology. By default, the option is enabled.
<b>VT for Direct I/O</b>	Specify whether a Virtual Machine Monitor (VMM) can utilize the additional hardware capabilities provided by Intel Virtualization Technology for Direct I/O. By default, the option is enabled.
<b>Intel Trusted Execution Technology (TXT)</b>	

**Table 50. System setup options—Virtualization Support menu (continued)**

<b>Virtualization Support</b>	
Enable Intel Trusted Execution Technology (TXT)	Specifies whether a measured Virtual Machine Monitor (MVMM) can utilize the additional hardware capabilities provided by Intel Trusted Execution Technology.  By default, the option is disabled.
<b>DMA Protection</b>	
Enable Pre-Boot DMA Support	Enable or disable Pre-BootDMA Support.  By default, the option is <b>enabled</b> .
Enable OS Kernel DMA Support	Enable or disable OS Kernel DMA Support.  By default, the option is <b>enabled</b> .

**Table 51. System setup options—Performance menu**

<b>Performance</b>	
<b>Multi Core Support</b>	
All Cores	Enables to change the number of CPU cores available to the operating system.  By default, the <b>All Cores</b> options is enabled.
<b>Multi Atom Cores</b>	
Multi Atom Cores	Enables to change the number of CPU multi-atom cores available to the operating system.  By default, the <b>All Cores</b> options is enabled.
<b>Intel SpeedStep</b>	
Enable Intel SpeedStep Technology	Enables the computer to dynamically adjust processor voltage and core frequency, decreasing average power consumption and heat production.  By default, the option is enabled.
<b>C-States Control</b>	
Enable C-State Control	Enable or disable additional processor sleep states.  By default, the option is <b>enabled</b> .
<b>Intel Turbo Boost Technology</b>	
Enable Intel Turbo Boost Technology	Enable or disable Intel TurboBoost mode of the processor.  By default, the option is enabled.
<b>Intel Hyper-Threading Technology</b>	
Enable Intel Hyper-Threading Technology	Enable or disable Hyper-Threading in the processor.  By default, the option is enabled.
<b>Dynamic Tuning:Machine Learning</b>	
Enable Dynamic Tuning:Machine Learning	Enables the operating system capability to enhance dynamic power tuning capabilities based on detected workloads.  By default, the option is disabled.

**Table 52. System setup options—System Logs menu**

<b>System Logs</b>	
<b>BIOS Event Log</b>	
Clear BIOS Event Log	Display BIOS events.

**Table 52. System setup options—System Logs menu (continued)**

System Logs	
	By default, the <b>Keep Log</b> option is enabled.
<b>Thermal Event Log</b>	
Clear Thermal Event Log	Display Thermal events. By default, the <b>Keep Log</b> option is enabled.
<b>Power Event Log</b>	
Clear Power Event Log	Display power events. By default, the <b>Keep Log</b> option is enabled.

## Updating the BIOS

### Updating the BIOS in Windows

#### About this task

 **CAUTION:** If BitLocker is not suspended before updating the BIOS, the next time you reboot the system it will not recognize the BitLocker key. You will then be prompted to enter the recovery key to progress and the system will ask for this on each reboot. If the recovery key is not known this can result in data loss or an unnecessary operating system re-install. For more information on this subject, search in the Knowledge Base Resource at [www.dell.com/support](http://www.dell.com/support).

#### Steps

1. Go to [www.dell.com/support](http://www.dell.com/support).
2. Click **Product support**. In the **Search support** box, enter the Service Tag of your computer, and then click **Search**.  
 **NOTE:** If you do not have the Service Tag, use the SupportAssist feature to automatically identify your computer. You can also use the product ID or manually browse for your computer model.
3. Click **Drivers & Downloads**. Expand **Find drivers**.
4. Select the operating system installed on your computer.
5. In the **Category** drop-down list, select **BIOS**.
6. Select the latest version of BIOS, and click **Download** to download the BIOS file for your computer.
7. After the download is complete, browse the folder where you saved the BIOS update file.
8. Double-click the BIOS update file icon and follow the on-screen instructions.  
For more information, search in the Knowledge Base Resource at [www.dell.com/support](http://www.dell.com/support).

### Updating the BIOS in Linux and Ubuntu

To update the system BIOS on a computer that is installed with Linux or Ubuntu, see the knowledge base article [000131486](https://www.dell.com/support) at [www.dell.com/support](http://www.dell.com/support).

### Updating the BIOS using the USB drive in Windows

#### About this task

 **CAUTION:** If BitLocker is not suspended before updating the BIOS, the next time you reboot the system it will not recognize the BitLocker key. You will then be prompted to enter the recovery key to progress and the system will ask for this on each reboot. If the recovery key is not known this can result in data loss or an

unnecessary operating system re-install. For more information on this subject, search in the Knowledge Base Resource at [www.dell.com/support](http://www.dell.com/support).

### Steps

1. Follow the procedure from step 1 to step 6 in [Updating the BIOS in Windows](#) to download the latest BIOS setup program file.
2. Create a bootable USB drive. For more information, search in the Knowledge Base Resource at [www.dell.com/support](http://www.dell.com/support).
3. Copy the BIOS setup program file to the bootable USB drive.
4. Connect the bootable USB drive to the computer that needs the BIOS update.
5. Restart the computer and press **F12**.
6. Select the USB drive from the **One Time Boot Menu**.
7. Type the BIOS setup program filename and press **Enter**.  
The **BIOS Update Utility** appears.
8. Follow the on-screen instructions to complete the BIOS update.

## Updating the BIOS from the F12 One-Time boot menu

Update your computer BIOS using BIOSConnect

### About this task

#### BIOSConnect

BIOSConnect provides a support network that enables the BIOS to perform Firmware Update Over The Air (FOTA) and also to recover the operating system.

For more information about updating BIOS using FOTA, see <https://www.dell.com/support/home/product-support/product/bios-connect/docs>.

## System and setup password

Table 53. System and setup password

Password type	Description
System password	Password that you must enter to log in to your system.
Setup password	Password that you must enter to access and make changes to the BIOS settings of your computer.

You can create a system password and a setup password to secure your computer.

 **CAUTION:** The password features provide a basic level of security for the data on your computer.

 **CAUTION:** Anyone can access the data that is stored on your computer if it is not locked and left unattended.

 **NOTE:** System and setup password feature is disabled.

## Assigning a system setup password

### Prerequisites

You can assign a new **System or Admin Password** only when the status is in **Not Set**.

### About this task

To enter the system setup, press F12 immediately after a power-on or reboot.



## Steps

1. In the **System BIOS** or **System Setup** screen, select **Security** and press Enter.  
The **Security** screen is displayed.
2. Select **System/Admin Password** and create a password in the **Enter the new password** field.  
Use the following guidelines to assign the system password:
  - A password can have up to 32 characters.
  - At least one special character: ! " # \$ % & ' ( ) \* + , - . / : ; < = > ? @ [ \ ] ^ \_ ` { | }
  - Numbers 0 through 9.
  - Upper case letters from A to Z.
  - Lower case letters from a to z.
3. Type the system password that you entered earlier in the **Confirm new password** field and click **OK**.
4. Press Esc and save the changes as prompted by the pop-up message.
5. Press Y to save the changes.  
The computer restarts.

## Deleting or changing an existing system setup password

### Prerequisites

Ensure that the **Password Status** is Unlocked (in the System Setup) before attempting to delete or change the existing System and/or Setup password. You cannot delete or change an existing System or Setup password, if the **Password Status** is Locked.

### About this task

To enter the System Setup, press F12 immediately after a power-on or reboot.

## Steps

1. In the **System BIOS** or **System Setup** screen, select **System Security** and press Enter.  
The **System Security** screen is displayed.
2. In the **System Security** screen, verify that **Password Status** is **Unlocked**.
3. Select **System Password**, update, or delete the existing system password, and press Enter or Tab.
4. Select **Setup Password**, update, or delete the existing setup password, and press Enter or Tab.  
 **NOTE:** If you change the System and/or Setup password, reenter the new password when prompted. If you delete the System and/or Setup password, confirm the deletion when prompted.
5. Press Esc and a message prompts you to save the changes.
6. Press Y to save the changes and exit from System Setup.  
The computer restarts.

## Clearing CMOS settings

### About this task

 **CAUTION:** Clearing CMOS settings will reset the BIOS settings on your computer.

## Steps

1. Remove the [base cover](#).
2. Disconnect the battery cable from the system board.
3. Remove the [coin-cell battery](#).
4. Wait for one minute.
5. Install the [coin-cell battery](#).
6. Connect the battery cable to the system board.

7. Install the [base cover](#).

## Clearing BIOS (System Setup) and System passwords

### About this task

To clear the system or BIOS passwords, contact Dell technical support as described at [www.dell.com/contactdell](http://www.dell.com/contactdell).

**NOTE:** For information on how to reset Windows or application passwords, refer to the documentation accompanying Windows or your application.

## Clearing Chassis Intrusion Alert

The computer features a chassis intrusion switch, which is able to detect any time the base cover has been removed from the computer.

Alerts to notify you of any intrusions can be enabled through the **Chassis Intrusion** field in the **Security** sub-menu of the BIOS setup menu.

When enabled, the **Block Boot Until Cleared** field allows you to choose whether to prevent normal boot up of the system until the intrusion alert is cleared.

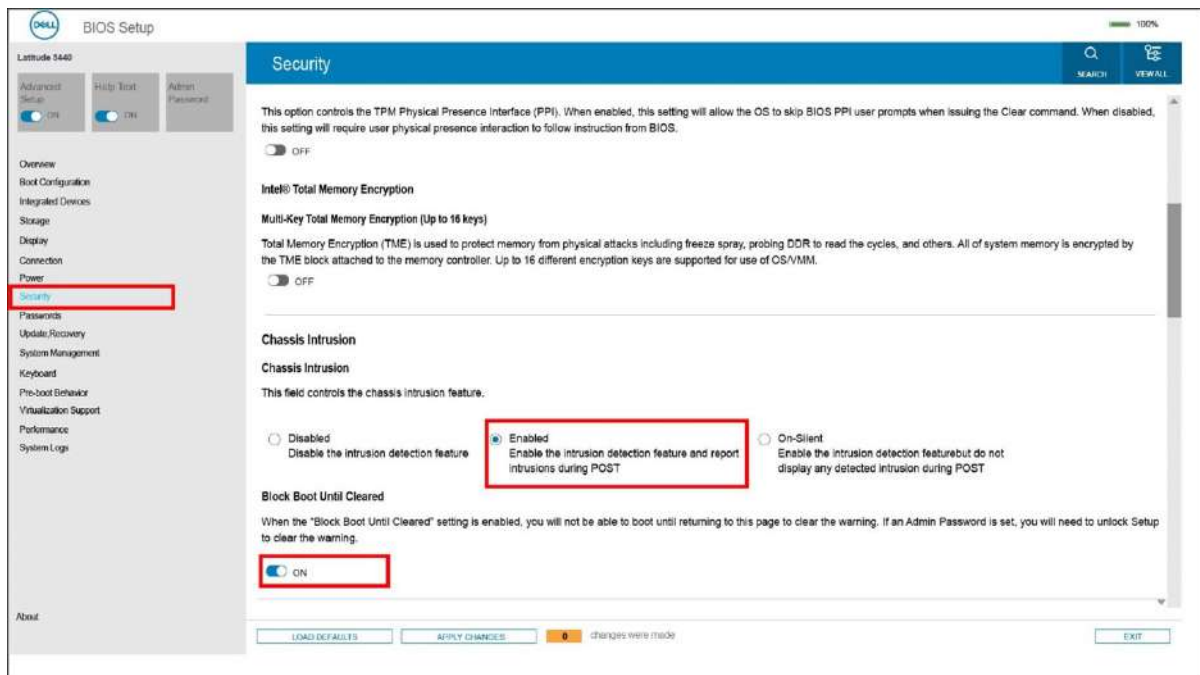

Figure 67. Security tab

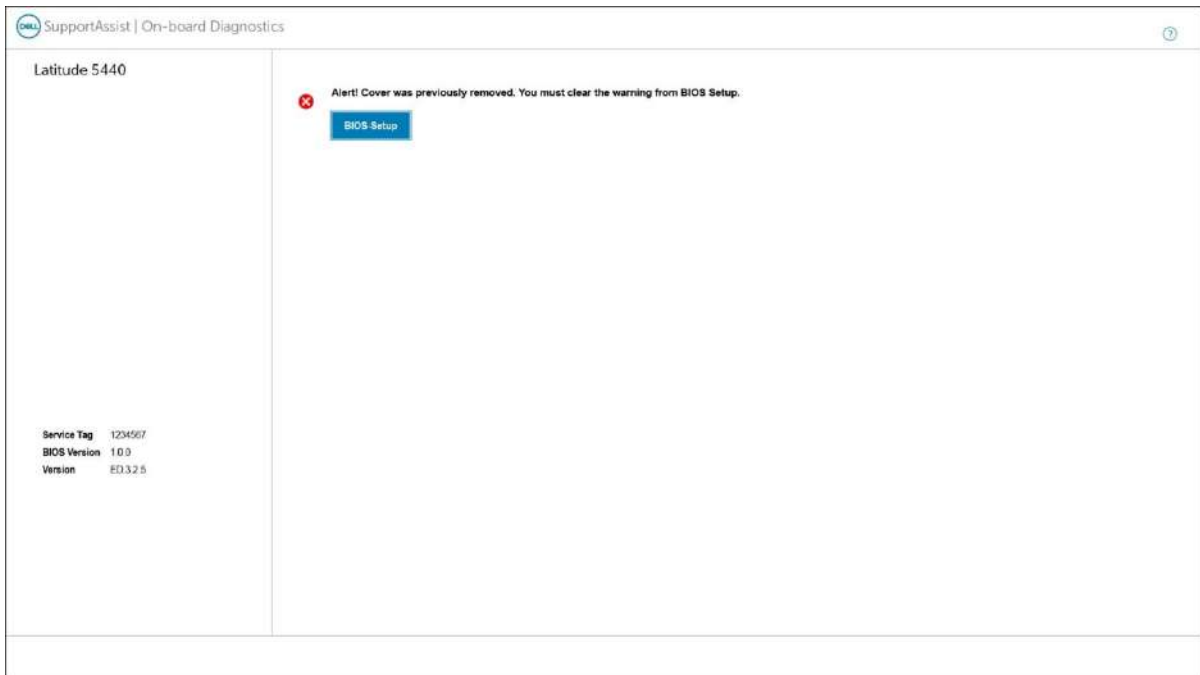

Figure 68. Alert message

If **Block Boot Until Cleared** is set to **OFF**, select **Continue** to boot up normally or **BIOS-Setup** to clear the alert.

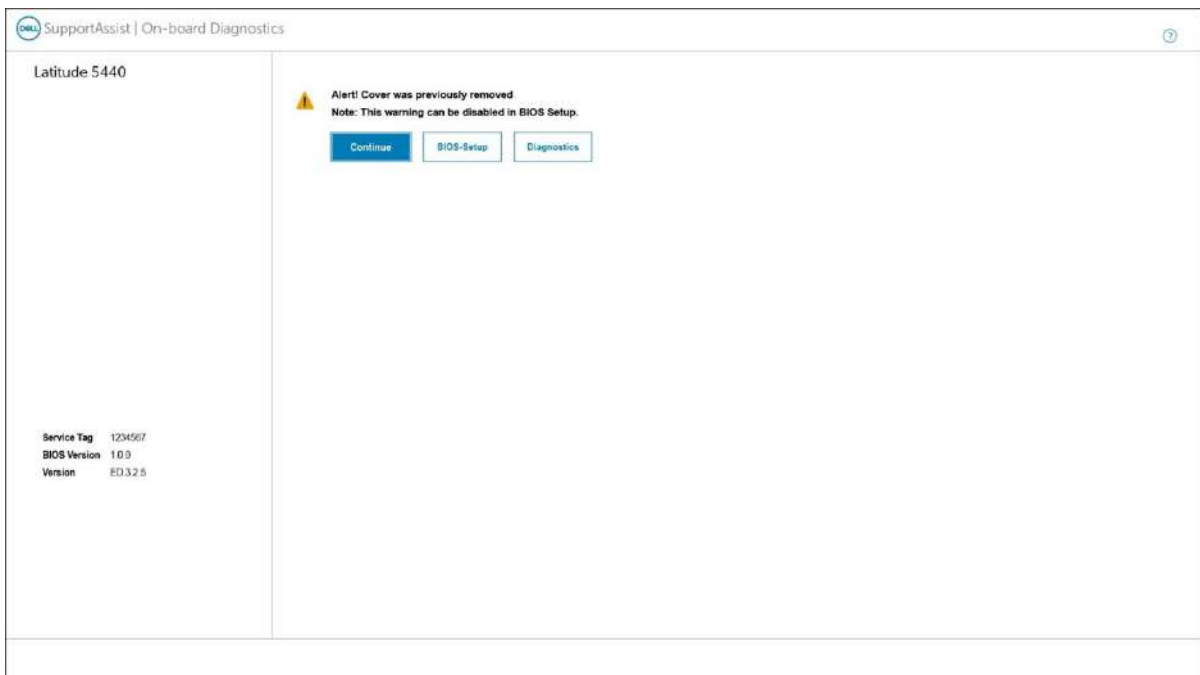

Figure 69. Alert message

**NOTE:** If **Continue** is selected, you will continue to see the alert each time the computer is turned on until the alert is cleared.

To clear the alert, select **ON** in the **Clear Intrusion Warning** field in the **Security** sub-menu of the BIOS setup menu.

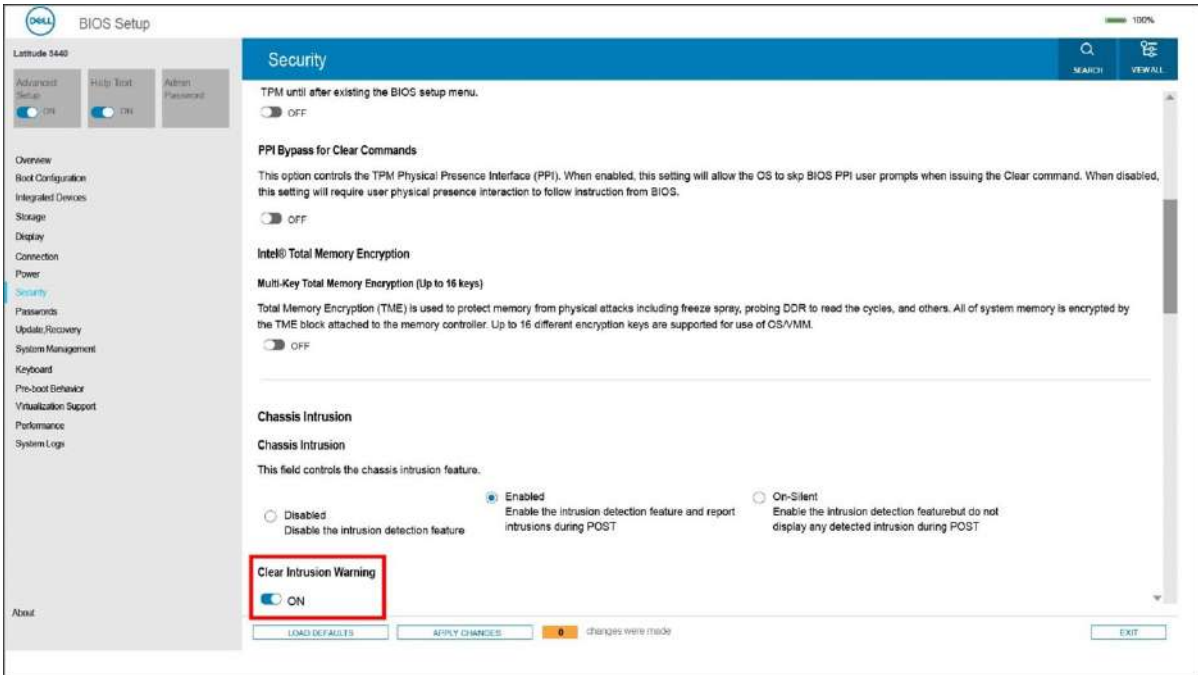

Figure 70. Security tab

# Troubleshooting

## Handling swollen Lithium-ion batteries

Like most laptops, Dell laptops use lithium-ion batteries. One type of lithium-ion battery is the lithium-ion polymer battery. Lithium-ion polymer batteries have increased in popularity in recent years and have become standard in the electronics industry due to customer preferences for a slim form factor (especially with newer ultra-thin laptops) and long battery life. Inherent to lithium-ion polymer battery technology is the potential for swelling of the battery cells.

Swollen battery may impact the performance of the laptop. To prevent possible further damage to the device enclosure or internal components leading to malfunction, discontinue the use of the laptop and discharge it by disconnecting the AC adapter and letting the battery drain.

Swollen batteries should not be used and should be replaced and disposed of properly. We recommend contacting Dell product support for options to replace a swollen battery under the terms of the applicable warranty or service contract, including options for replacement by a Dell authorized service technician.

The guidelines for handling and replacing Lithium-ion batteries are as follows:

- Exercise caution when handling Lithium-ion batteries.
- Discharge the battery before removing it from the system. To discharge the battery, unplug the AC adapter from the system and operate the system only on battery power. When the system will no longer power on when the power button is pressed, the battery is fully discharged.
- Do not crush, drop, mutilate, or penetrate the battery with foreign objects.
- Do not expose the battery to high temperatures, or disassemble battery packs and cells.
- Do not apply pressure to the surface of the battery.
- Do not bend the battery.
- Do not use tools of any type to pry on or against the battery.
- If a battery gets stuck in a device as a result of swelling, do not try to free it as puncturing, bending, or crushing a battery can be dangerous.
- Do not attempt to reassemble a damaged or swollen battery into a laptop.
- Swollen batteries that are covered under warranty should be returned to Dell in an approved shipping container (provided by Dell)—this is to comply with transportation regulations. Swollen batteries that are not covered under warranty should be disposed of at an approved recycling center. Contact Dell product support at <https://www.dell.com/support> for assistance and further instructions.
- Using a non-Dell or incompatible battery may increase the risk of fire or explosion. Replace the battery only with a compatible battery purchased from Dell that is designed to work with your Dell computer. Do not use a battery from other computers with your computer. Always purchase genuine batteries from <https://www.dell.com> or otherwise directly from Dell.

Lithium-ion batteries can swell for various reasons such as age, number of charge cycles, or exposure to high heat. For more information on how to improve the performance and lifespan of the laptop battery and to minimize the possibility of occurrence of the issue, search Dell Laptop Battery in the Knowledge Base Resource at [www.dell.com/support](http://www.dell.com/support).

## Locate the Service Tag or Express Service Code of your Dell computer

Your Dell computer is uniquely identified by a Service Tag or Express Service Code. To view relevant support resources for your Dell computer, we recommend entering the Service Tag or Express Service Code at [www.dell.com/support](http://www.dell.com/support).

For more information on how to find the Service Tag for your computer, see [Locate the Service Tag on your computer](#).

# Dell SupportAssist Pre-boot System Performance Check diagnostics

## About this task

SupportAssist diagnostics (also known as system diagnostics) performs a complete check of your hardware. The Dell SupportAssist Pre-boot System Performance Check diagnostics is embedded with the BIOS and is launched by the BIOS internally. The embedded system diagnostics provides a set of options for particular devices or device groups allowing you to:

- Run tests automatically or in an interactive mode
- Repeat tests
- Display or save test results
- Run thorough tests to introduce additional test options to provide extra information about the failed device(s)
- View status messages that inform you if tests are completed successfully
- View error messages that inform you of problems encountered during testing

 **NOTE:** Some tests for specific devices require user interaction. Always ensure that you are present at the computer terminal when the diagnostic tests are performed.

For more information, see <https://www.dell.com/support/kbdoc/000180971>.

## Running the SupportAssist Pre-Boot System Performance Check

### Steps

1. Turn on your computer.
2. As the computer boots, press the F12 key as the Dell logo appears.
3. On the boot menu screen, select the **Diagnostics** option.
4. Click the arrow at the bottom left corner.  
Diagnostics front page is displayed.
5. Click the arrow in the lower-right corner to go to the page listing.  
The items detected are listed.
6. To run a diagnostic test on a specific device, press Esc and click **Yes** to stop the diagnostic test.
7. Select the device from the left pane and click **Run Tests**.
8. If there are any issues, error codes are displayed.  
Note the error code and validation number and contact Dell.

## Built-in self-test (BIST)

### M-BIST

M-BIST (Built In Self-Test) is the system board's built-in self-test diagnostics tool that improves the diagnostics accuracy of system board embedded controller (EC) failures.

 **NOTE:** M-BIST can be manually initiated before POST (Power On Self Test).

### How to run M-BIST

 **NOTE:** M-BIST must be initiated on the system from a power-off state either connected to AC power or with battery only.

1. Press and hold both the **M** key on the keyboard and the **power button** to initiate M-BIST.
2. With both the **M** key and the **power button** held down, the battery indicator LED may exhibit two states:
  - a. OFF: No fault detected with the system board
  - b. AMBER: Indicates a problem with the system board
3. If there is a failure with the system board, the battery status LED will flash one of the following error codes for 30 seconds:

**Table 54. LED error codes**

Blinking Pattern		Possible Problem
Amber	White	
2	1	CPU Failure
2	8	LCD Power Rail Failure
1	1	TPM Detection Failure
1	2	Unrecoverable SPI Flash Failure

4. If there is no failure with the system board, the LCD will cycle through the solid color screens described in the LCD-BIST section for 30 seconds and then power off.

## LCD Power rail test (L-BIST)

L-BIST is an enhancement to the single LED error code diagnostics and is automatically initiated during POST. L-BIST will check the LCD power rail. If there is no power being supplied to the LCD (that is if the L-BIST circuit fails), the battery status LED will flash either an error code [2,8] or an error code [2,7].

 **NOTE:** If L-BIST fails, LCD-BIST cannot function as no power will be supplied to the LCD.

### How to invoke L-BIST Test:

1. Press the power button to start the system.
2. If the system does not start up normally, look at the battery status LED:
  - If the battery status LED flashes an error code [2,7], the display cable may not be connected properly.
  - If the battery status LED flashes an error code [2,8], there is a failure on the LCD power rail of the system board, hence there is no power supplied to the LCD.
3. For cases, when a [2,7] error code is shown, check to see if the display cable is properly connected.
4. For cases when a [2,8] error code is shown, replace the system board.

## LCD Built-in Self Test (BIST)

Dell laptops have a built-in diagnostic tool that helps you determine if the screen abnormality you are experiencing is an inherent problem with the LCD (screen) of the Dell laptop or with the video card (GPU) and PC settings.

When you notice screen abnormalities like flickering, distortion, clarity issues, fuzzy or blurry image, horizontal or vertical lines, color fade etc., it is always a good practice to isolate the LCD (screen) by running the Built-In Self Test (BIST).

### How to invoke LCD BIST Test

1. Power off the Dell laptop.
2. Disconnect any peripherals that are connected to the laptop. Connect only the AC adapter (charger) to the laptop.
3. Ensure that the LCD (screen) is clean (no dust particles on the surface of the screen).
4. Press and hold **D** key and **Power on** the laptop to enter LCD built-in self test (BIST) mode. Continue to hold the D key, until the system boots up.
5. The screen will display solid colors and change colors on the entire screen to white, black, red, green, and blue twice.
6. Then it will display the colors white, black and red.
7. Carefully inspect the screen for abnormalities (any lines, fuzzy color or distortion on the screen).
8. At the end of the last solid color (red), the system will shut down.

 **NOTE:** Dell SupportAssist Pre-boot diagnostics upon launch, initiates an LCD BIST first, expecting a user intervention confirm functionality of the LCD.

# System-diagnostic lights

## Power and battery-status light

The power and battery-status light indicates the power and battery status of the computer. These are the power states:

**Solid white:**Power adapter is connected and the battery has more than 5% charge.

**Amber:**Computer is running on battery and the battery has less than 5% charge.

### Off:

- Power adapter is connected, and the battery is fully charged.
- Computer is running on battery, and the battery has more than 5% charge.
- Computer is in sleep state, hibernation, or turned off.

The power and battery-status light may blink amber or white according to pre-defined "beep codes" indicating various failures.

For example, the power and battery-status light blinks amber two times followed by a pause, and then blinks white three times followed by a pause. This 2,3 pattern continues until the computer is turned off, indicating no memory or RAM is detected.

The following table shows different power and battery-status light patterns and associated problems.

**i NOTE:** The following diagnostic light codes and recommended solutions are intended for Dell service technicians to troubleshoot problems. You should only perform troubleshooting and repairs as authorized or directed by the Dell technical assistance team. Damage due to servicing that is not authorized by Dell is not covered by your warranty.

**Table 55. Diagnostic-light LED codes**

Diagnostic light codes (Amber,White)	Problem description
1,1	TPM detection failure
1,2	Unrecoverable SPI Flash Failure
1,3	Short in hinge cable tripped OCP1
1,4	Short in hinge cable tripped OCP2
1,5	EC unable to program i-Fuse
1,6	Generic catch-all for ungraceful EC code flow errors
1,7	Non-RPMC flash on boot guard fused system
2,1	Processor failure
2,2	System board: BIOS or Read-Only Memory (ROM) failure
2,3	No memory or Random-Access Memory (RAM) detected
2,4	Memory or Random-Access Memory (RAM) failure
2,5	Invalid memory installed
2,6	System-board or chipset error
2,7	Display failure - SBIOS message
3,1	Coin-cell battery failure
3,2	PCI, video card/chip failure
3,3	Recovery image not found
3,4	Recovery image found but invalid
3,5	Power-rail failure
3,6	System BIOS Flash incomplete
3,7	Management Engine (ME) error



# Recovering the operating system

When your computer is unable to boot to the operating system even after repeated attempts, it automatically starts Dell SupportAssist OS Recovery.

Dell SupportAssist OS Recovery is a standalone tool that is preinstalled in all Dell computers installed with Windows operating system. It consists of tools to diagnose and troubleshoot issues that may occur before your computer boots to the operating system. It enables you to diagnose hardware issues, repair your computer, back up your files, or restore your computer to its factory state.

You can also download it from the Dell Support website to troubleshoot and fix your computer when it fails to boot into their primary operating system due to software or hardware failures.

For more information about the Dell SupportAssist OS Recovery, see *Dell SupportAssist OS Recovery User's Guide* at [www.dell.com/serviceabilitytools](http://www.dell.com/serviceabilitytools). Click **SupportAssist** and then, click **SupportAssist OS Recovery**.

## Real-Time Clock (RTC Reset)

The Real Time Clock (RTC) reset function allows you or the service technician to recover Dell systems from No POST/No Power/No Boot situations. The legacy jumper enabled RTC reset has been retired on these models.

Start the RTC reset with the system powered off and connected to AC power. Press and hold the power button for thirty (30) seconds

. The system RTC Reset occurs after you release the power button.

## Backup media and recovery options

It is recommended to create a recovery drive to troubleshoot and fix problems that may occur with Windows. Dell proposes multiple options for recovering Windows operating system on your Dell PC. For more information, see [Dell Windows Backup Media and Recovery Options](#).

## Wi-Fi power cycle

### About this task

If your computer is unable to access the Internet due to Wi-Fi connectivity issues a Wi-Fi power cycle procedure may be performed. The following procedure provides the instructions on how to conduct a Wi-Fi power cycle:

 **NOTE:** Some ISPs (Internet Service Providers) provide a modem/router combo device.

### Steps

1. Turn off your computer.
2. Turn off the modem.
3. Turn off the wireless router.
4. Wait for 30 seconds.
5. Turn on the wireless router.
6. Turn on the modem.
7. Turn on your computer.

## Drain residual flea power (perform hard reset)

### About this task

Flea power is the residual static electricity that remains in the computer even after it has been powered off and the battery is removed.

For your safety, and to protect the sensitive electronic components in your computer, you are requested to drain residual flea power before removing or replacing any components in your computer.

Draining residual flea power, also known as a performing a "hard reset", is also a common troubleshooting step if your computer does not power on or boot into the operating system.

### **To drain residual flea power (perform a hard reset)**

#### **Steps**

1. Turn off your computer.
2. Disconnect the power adapter from your computer.
3. Remove the base cover.
4. Remove the battery.
5. Press and hold the power button for 20 seconds to drain the flea power.
6. Install the battery.
7. Install the base cover.
8. Connect the power adapter to your computer.
9. Turn on your computer.

 **NOTE:** For more information about performing a hard reset, search in the Knowledge Base Resource at [www.dell.com/support](http://www.dell.com/support).

# Getting help and contacting Dell

## Self-help resources

You can get information and help on Dell products and services using these self-help resources:

**Table 56. Self-help resources**

Self-help resources	Resource location
Information about Dell products and services	<a href="http://www.dell.com">www.dell.com</a>
Tips	
Contact Support	In Windows search, type <code>Contact Support</code> , and press Enter.
Online help for operating system	<a href="http://www.dell.com/support/windows">www.dell.com/support/windows</a> <a href="http://www.dell.com/support/linux">www.dell.com/support/linux</a>
Access top solutions, diagnostics, drivers and downloads, and learn more about your computer through videos, manuals and documents.	Your Dell computer is uniquely identified by a Service Tag or Express Service Code. To view relevant support resources for your Dell computer, enter the Service Tag or Express Service Code at <a href="http://www.dell.com/support">www.dell.com/support</a> .  For more information on how to find the Service Tag for your computer, see <a href="#">Locate the Service Tag on your computer</a> .
Dell knowledge base articles for a variety of computer concerns	<ol style="list-style-type: none"> <li>1. Go to <a href="http://www.dell.com/support">www.dell.com/support</a>.</li> <li>2. On the menu bar at the top of the Support page, select <b>Support &gt; Knowledge Base</b>.</li> <li>3. In the Search field on the Knowledge Base page, type the keyword, topic, or model number, and then click or tap the search icon to view the related articles.</li> </ol>

## Contacting Dell

To contact Dell for sales, technical support, or customer service issues, see [www.dell.com/contactdell](http://www.dell.com/contactdell).

 **NOTE:** Availability varies by country/region and product, and some services may not be available in your country/region.

 **NOTE:** If you do not have an active Internet connection, you can find contact information about your purchase invoice, packing slip, bill, or Dell product catalog.